



GIANT SCALE P-47 RAZORBACK 50-61cc/EP ARF

Code : SEA 306

ASSEMBLY MANUAL

“Graphics and specifications may change without notice”.



Specifications:

Wingspan----- 81.0 in (206.0 cm).
Wing area----- 1200.3 sq.ins (77.4 sq.dm).
Weight----- 22.0 lbs (10.0 kg).
Length----- 67.6 in (171.6 cm).
Engine/Motor size----- 50-61cc gasoline.
Radio----- 9 channels with 13 servos.

INTRODUCTION

Thank you for choosing the **GIANT SCALE P-47 RAZORBACK 50-61cc/EP ARF** ARTF by **SG MODELS**. The **GIANT SCALE P-47 RAZORBACK 50-61cc/EP ARF** was designed with the intermediate/advanced sport flyer in mind. It is a semi scale airplane which is easy to fly and quick to assemble. The airframe is conventionally built using balsa, plywood to make it stronger than the average ARTF, yet the design allows the aeroplane to be kept light. You will find that most of the work has been done for you already. The motor mount has been fitted and the hinges are pre-installed. Flying the **GIANT SCALE P-47 RAZORBACK 50-61cc/EP ARF** is simply a joy.

This instruction manual is designed to help you build a great flying aeroplane. Please read this manual throughly before starting assembly of your **GIANT SCALE P-47 RAZORBACK 50-61cc/EP ARF** Use the parts listing below to indentify all parts.

WARNING

Please be aware that this aeroplane is not a toy and if assembled or used incorrectly it is capable of causing injury to people or property. WHEN YOU FLY THIS AEROPLANE YOU ASSUME ALL RISK & REPONSIBILITY.

If you are inexperienced with basic R/C flight we strongly recommend you contact your R/C supplier and join your local R/C model Flying Club. R/C Model Flying Clubs offer a variety of training procedures designed to help the new pilot on his way to successful R/C flight. They will also be able to advise on any insurance and safety regulations that may apply.

KIT CONTENTS

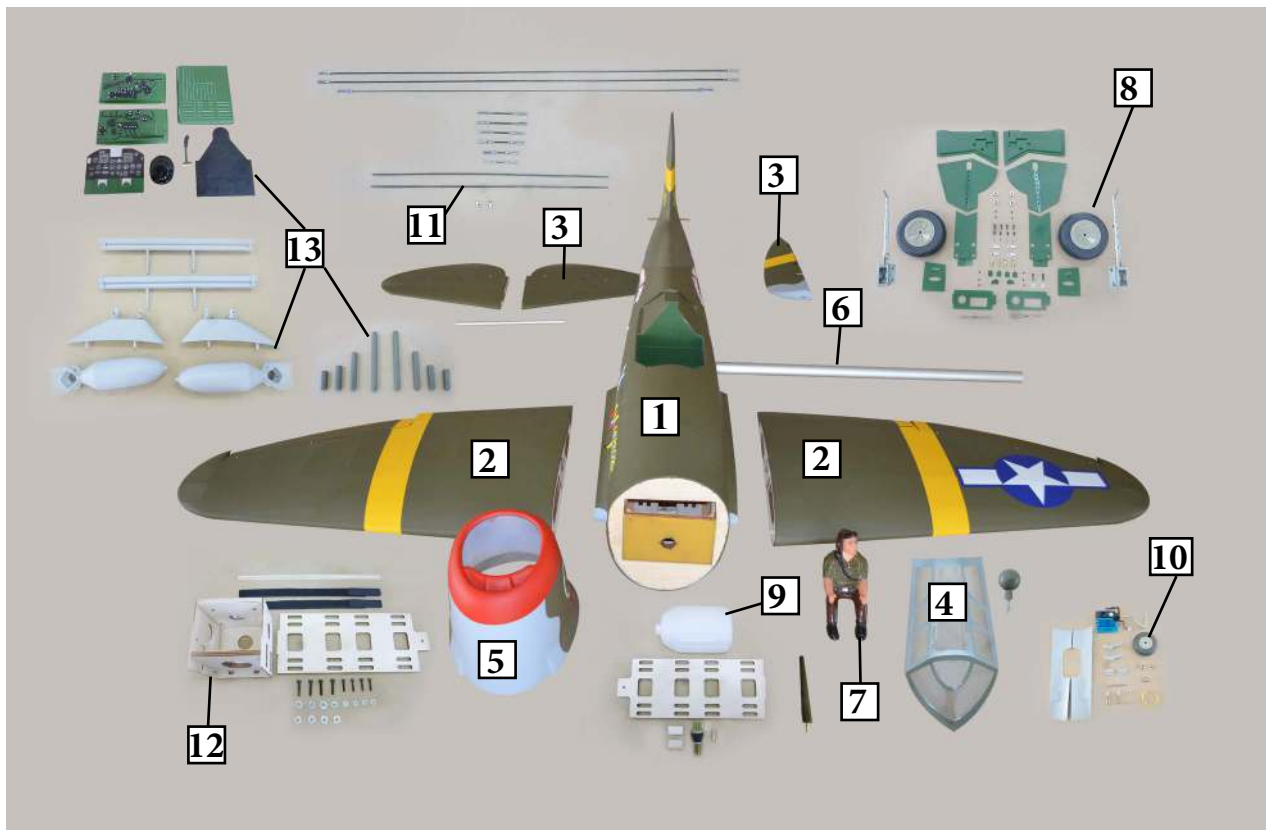

KIT CONTENTS

SEA306 GIANT SCALE P-47 RAZOR-BACK 50-61cc/EP ARF

1. Fuselage
2. Wing set (2)
3. Tail set (2)
4. Canopy
5. Cowling
6. Wing tube
7. Pilot
8. landing gear
9. Fuel tank
10. Tail wheel
11. Pushrod set
12. Ep Motor box
13. Bomb and gun

ADDITIONAL ITEMS REQUIRED

- 50-61cc gasoline engine.
- Computer radio 9-12 channel with 13 servos.
- Glow plug to suit engine.
- Propeller to suit engine.
- Protective foam rubber for radio system.
- Aircraft shelves.

TOOLS & SUPPLIES NEEDED

- Thin cyanoacrylate glue.
- Medium cyanoacrylate glue.
- 30 minute epoxy.
- 5 minute epoxy.
- Hand or electric drill.
- Assorted drill bits.
- Modelling knife.
- Straight edge ruler.
- 2mm ball driver.
- Phillips head screwdriver.
- 220 grit sandpaper.
- 90° square or builder's triangle.
- Wire cutters.
- Masking tape & T-pins.
- Thread-lock.
- Paper towels.

INSTALL THE AILERONS CONTROL HORN

1.

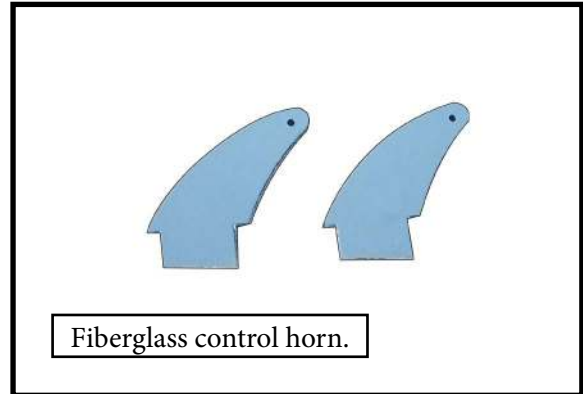

2.

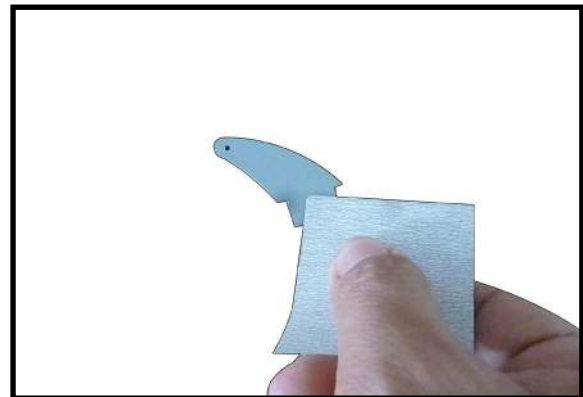

3.

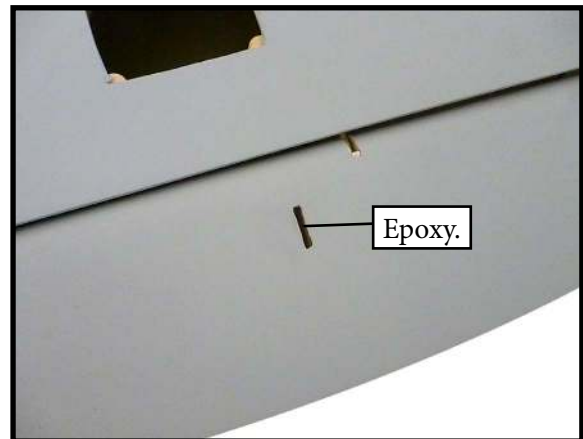

4.

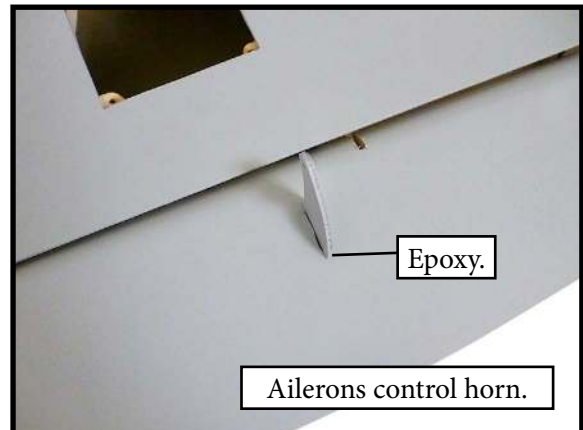

INSTALLING THE AILERON SERVOS

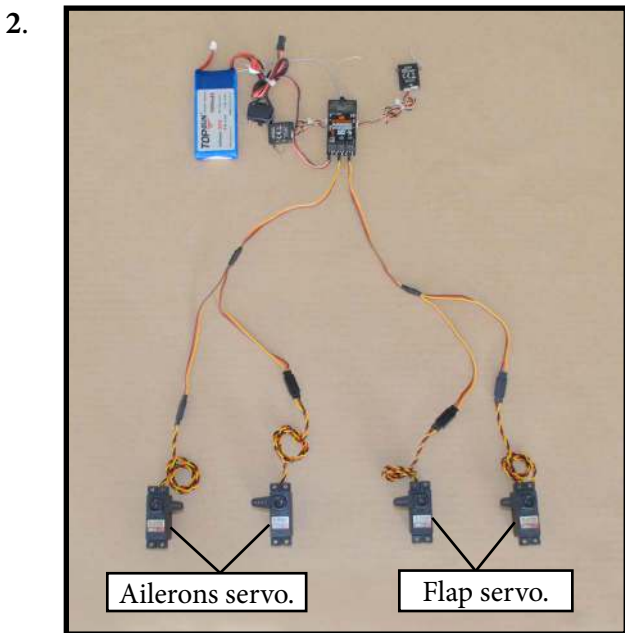
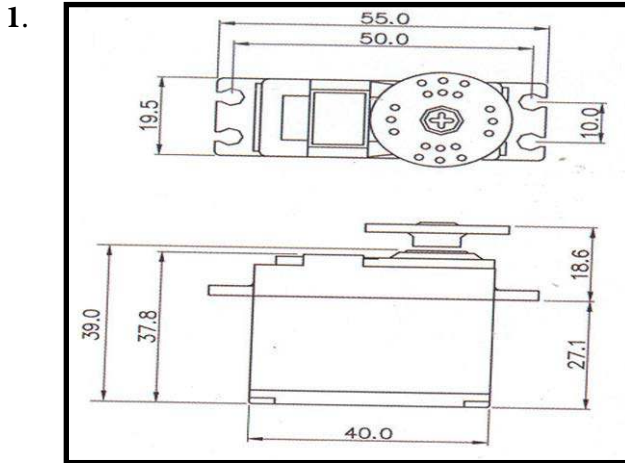

Minimum servo spec.
Torque : 110 oz-in (7.9 kg-cm) @ 4.8V;
 131 oz-in (9.4 kg-cm) @ 6.0V

⚠ Because the size of servos differ, you may need to adjust the size of the precut opening in the mount. The notch in the sides of the mount allow the servo lead to pass through.

Place the servo between the mounting blocks and space it from the hatch. Use a pencil to mark the mounting hole locations on the blocks.

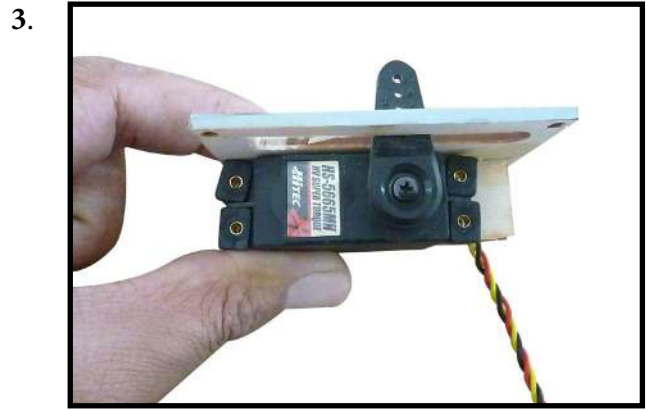

Use drill bit in a pin vise to drill the mounting holes in the blocks.

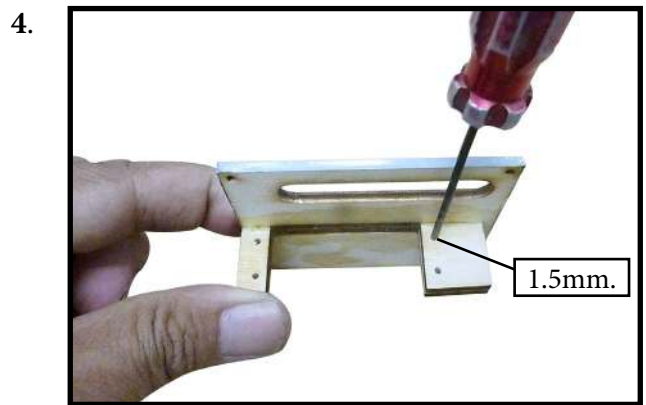

Apply 2-3 drops of thin C/A to each of the mounting holes. Allow the C/A to cure without using accelerator.

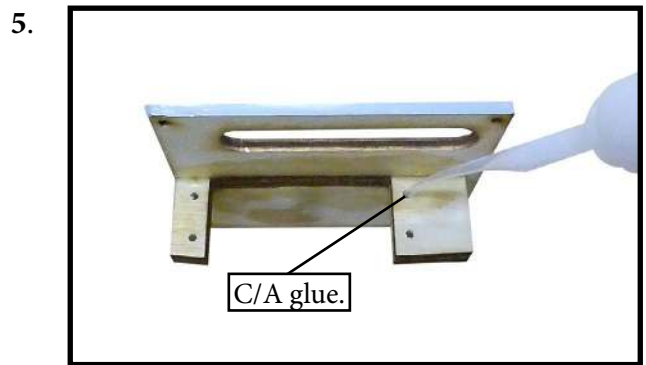

Use dental floss or heatshrink tube to secure the connection so they cannot become unplugged.

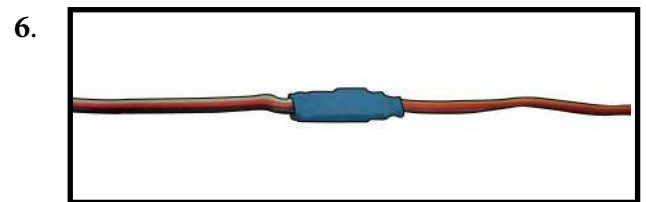

Secure the servo to the aileron hatch using Phillips screwdriver and the screws provided with the servo.



Apply 1-2 drops of thin C/A to each of the mounting tabs. Allow the C/A to cure without using accelerator.

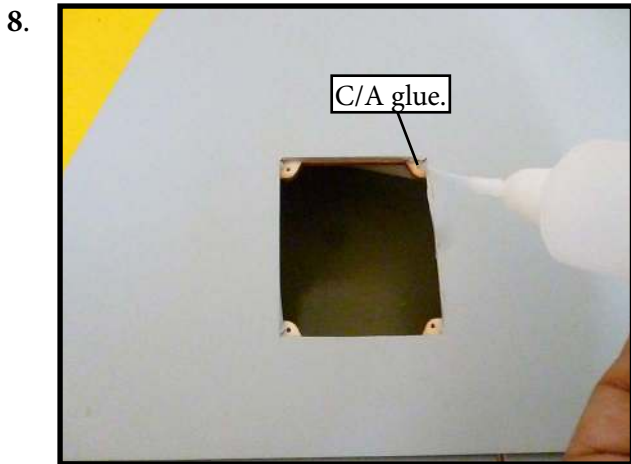

Remove the string from the wing at the servo location and use the tape to attach it to the servo extension lead. Pull the lead through the wing and remove the string.

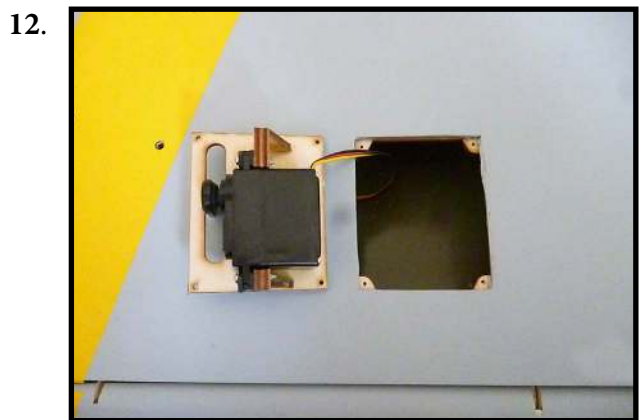
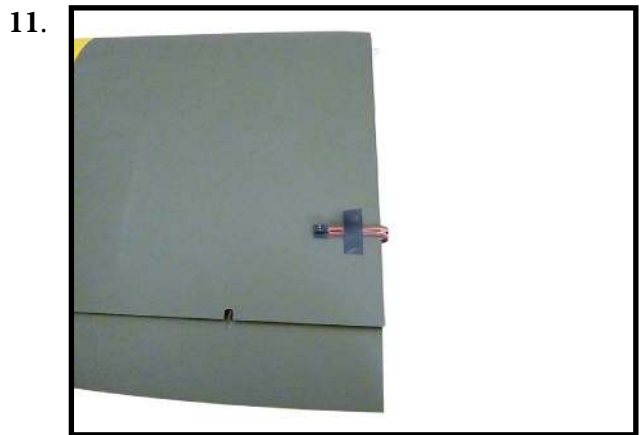
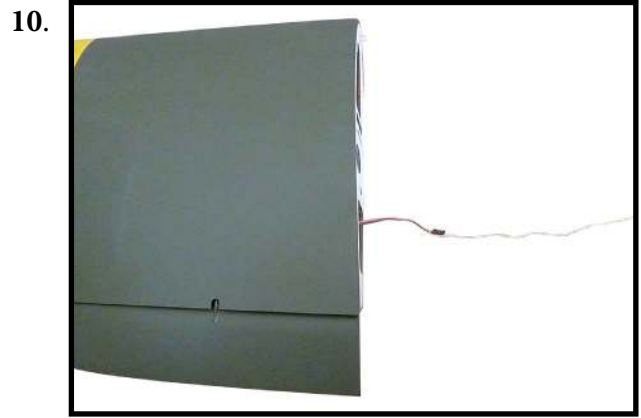
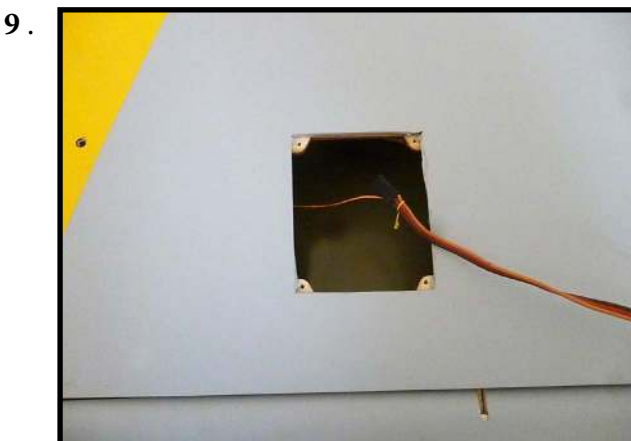

Set the aileron hatch in place and use a Phillips screw driver to install it with four wood screws.

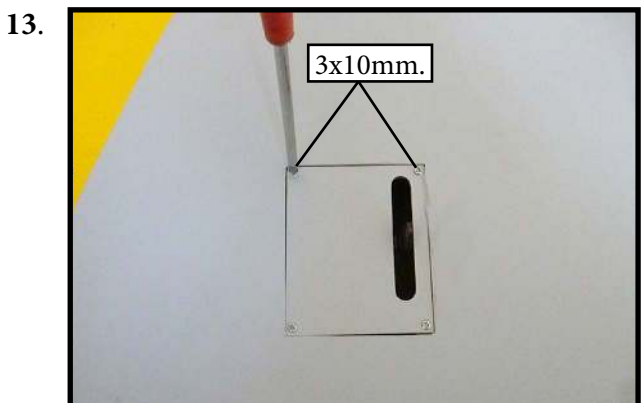

14.

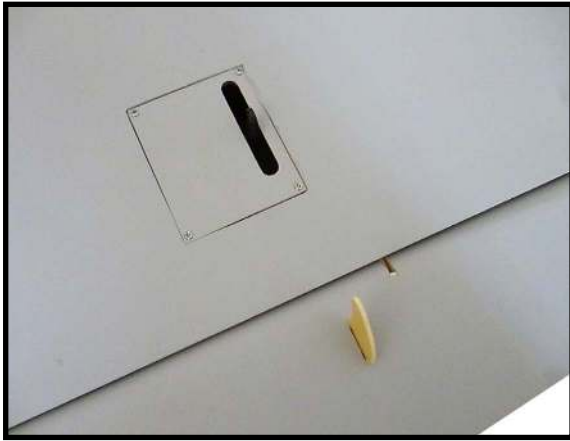

AILERON PUSHROD INSTALLATION

Please see below pictures.

1.

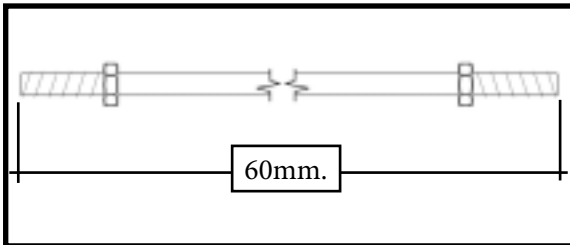

2.

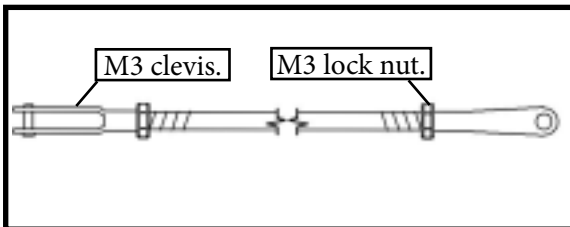

3.

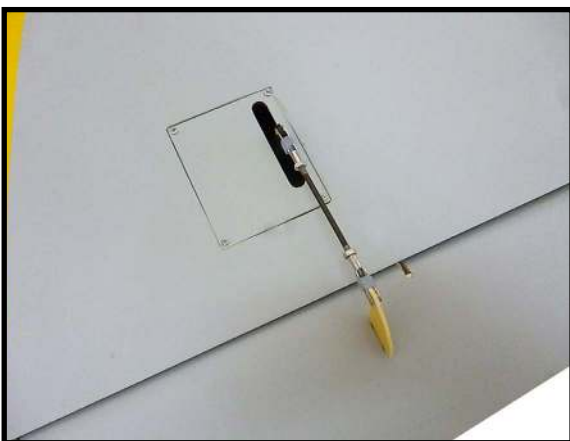

INSTALLING THE FLAP PUSHROD

Please see below pictures.

1.

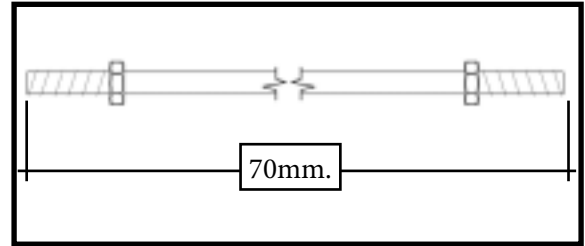

2.

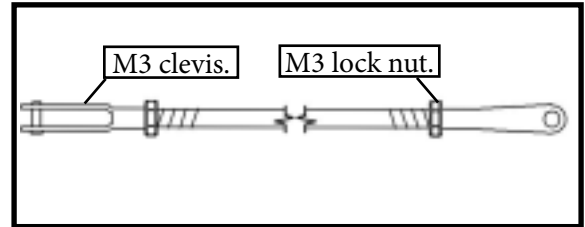

Attach the flap servo to the flap servo cover. Center the flap servo (or set the values to 0 for both up and down) and install the servo arm perpendicular to the servo centerline. The clevis will attach to the arm 13/16 inches (21mm) from the center of the arm.

3.

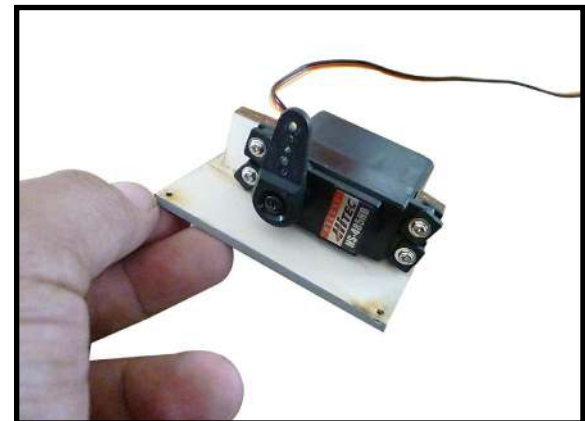

4.

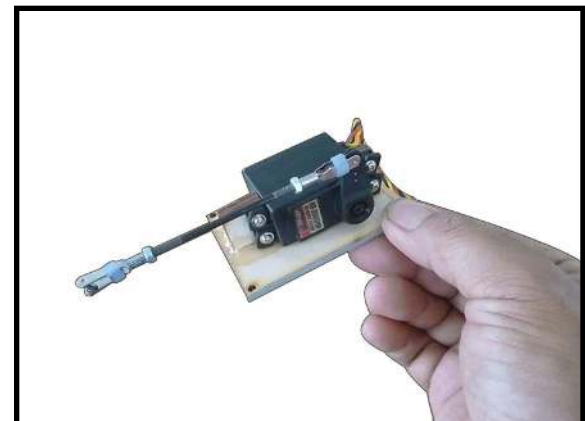

Attach the flap linkage to the control horn. Slide the clevis retainer over the forks of the clevis.

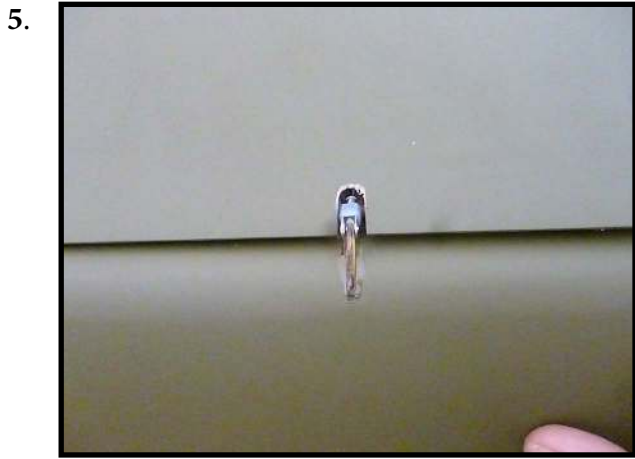

Attach the clevis to the flap servo arm.

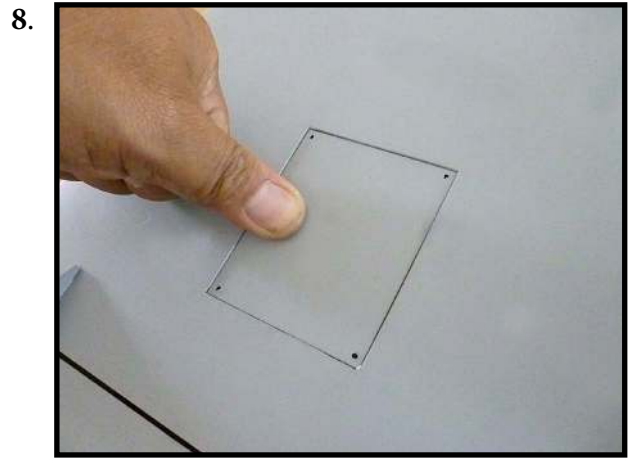

Adjust the linkage so the flap is in the mid-flap position. It may take a few tries to properly adjust the linkage.

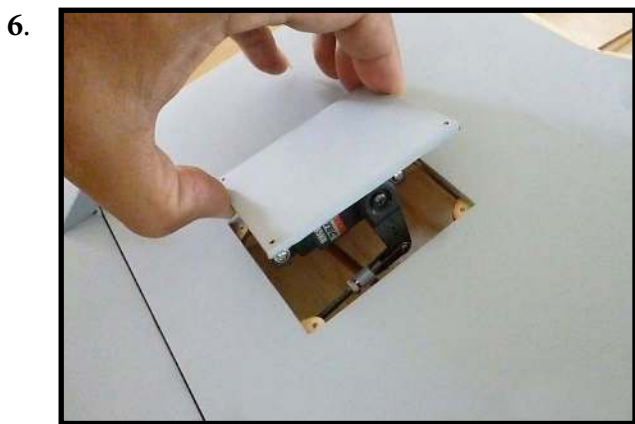

Use a pin vise and 3/32-inch (2mm) drill bit to clear the paint from the flap control horn.

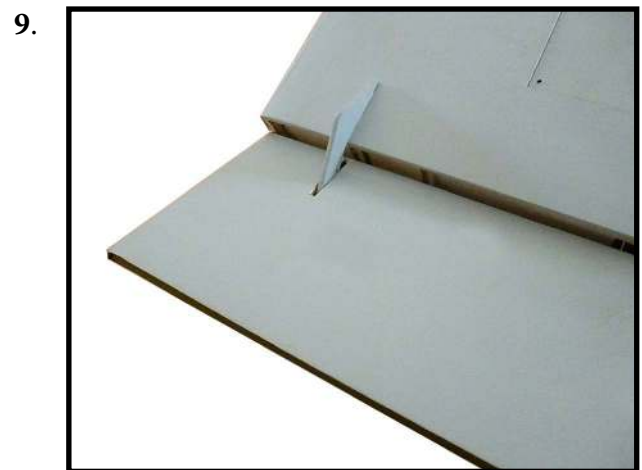

Once adjusted, make sure all clevis retainers are in position. Apply a drop of threadlock near the clevis, then tighten the nut against the clevis to keep the linkage from changing length inside the wing.

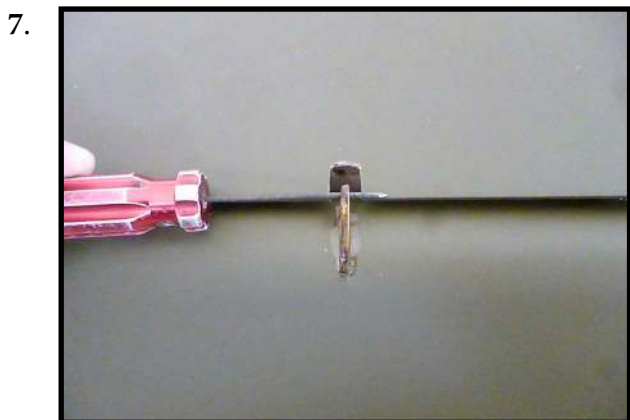

Route the servo lead for the flap servo out at the root of the wing. Connect the flap servo to the radio system. With the radio system on, place the flap servo into position.

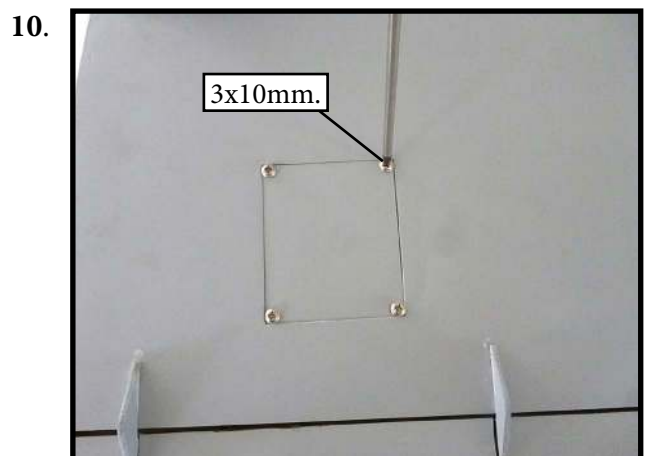

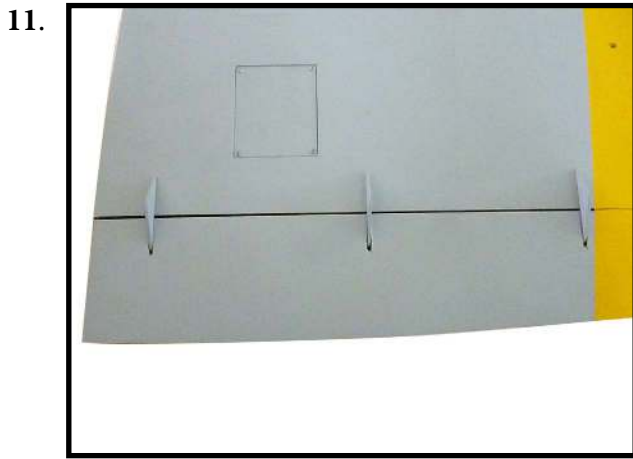

Set the flap control at the transmitter to the down flap position. Adjust the flap travel at the transmitter until it matches the control throws listed in this manual.

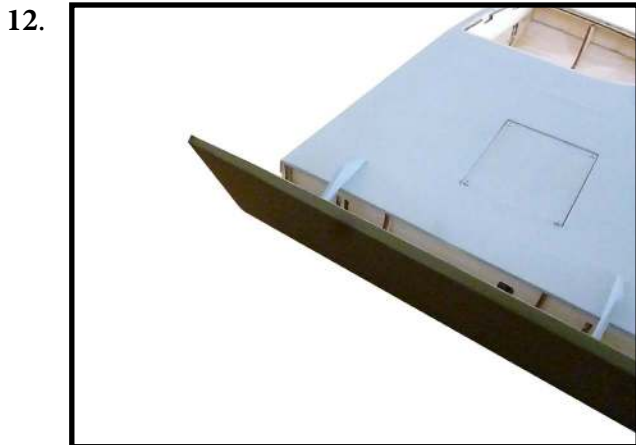

Trim the flap linkage cover using a hobby knife and hobby scissors.



Fit the flap linkage cover into position. Check the operation of the flap to make sure the cover does not interfere with the flap linkage.

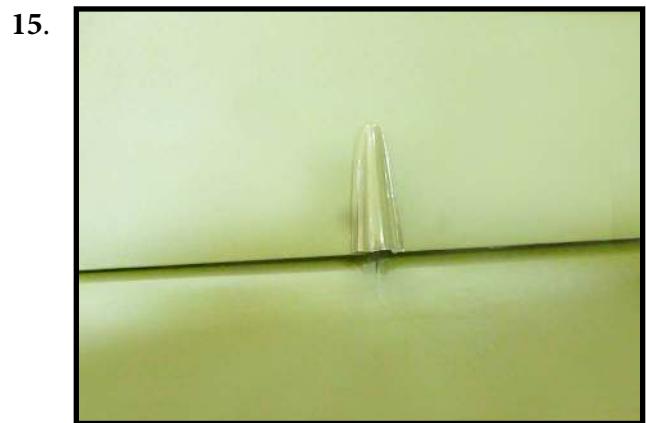

Use canopy glue to attach the cover to the wing. Use low-tack tape to keep the cover in position until the adhesive fully cures.

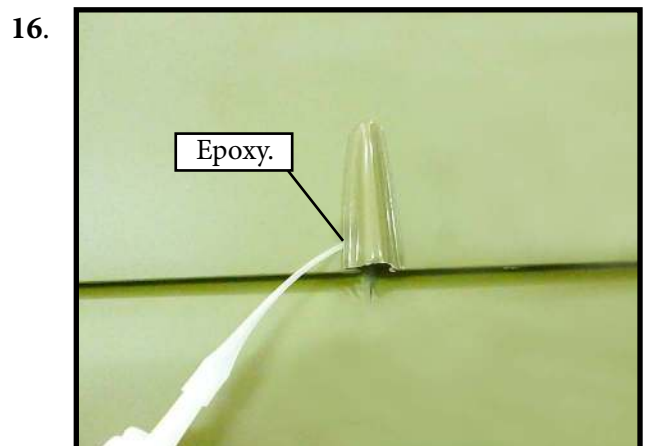

INSTALLING LANDING GEAR

Locate items necessary to install Sprin Landing Gear.

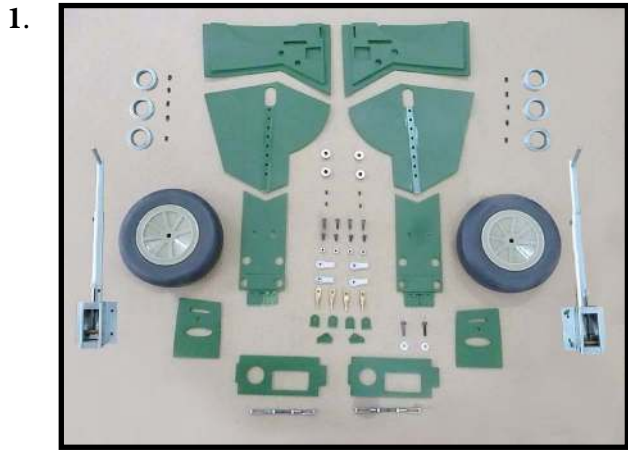

Install retractable landing gear at the Wing.

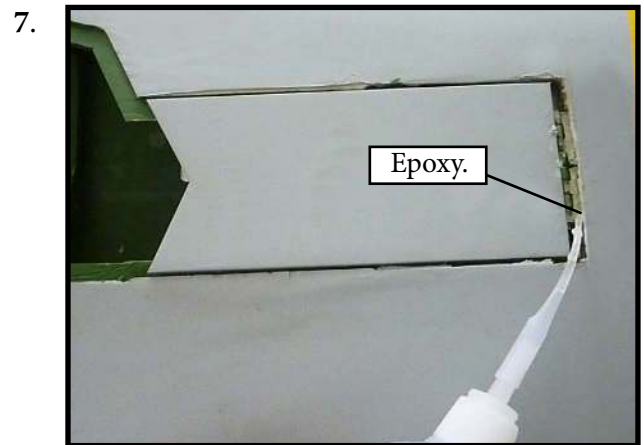
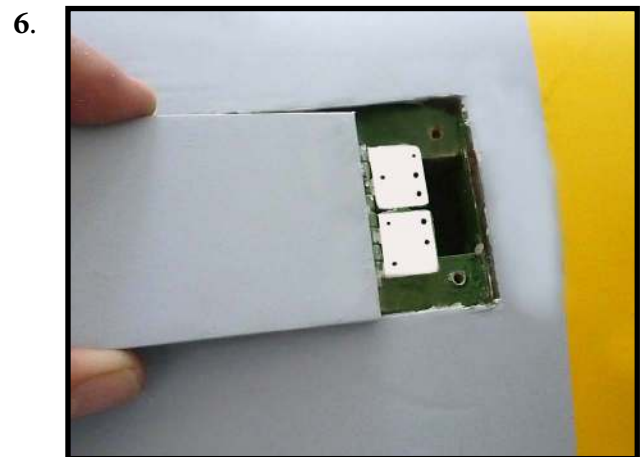
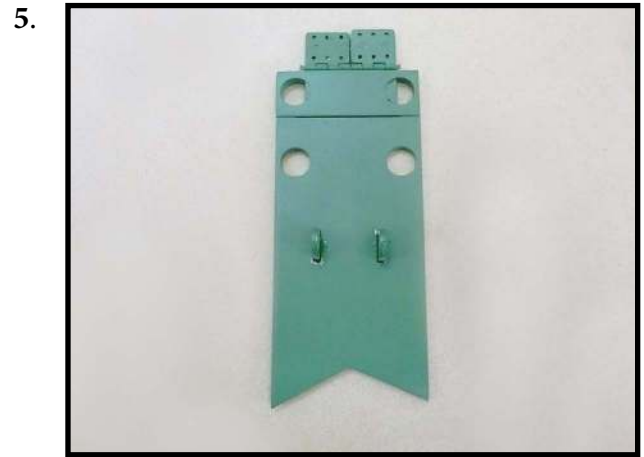
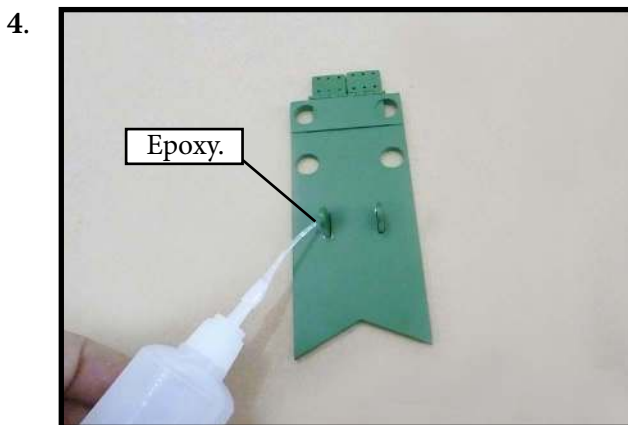
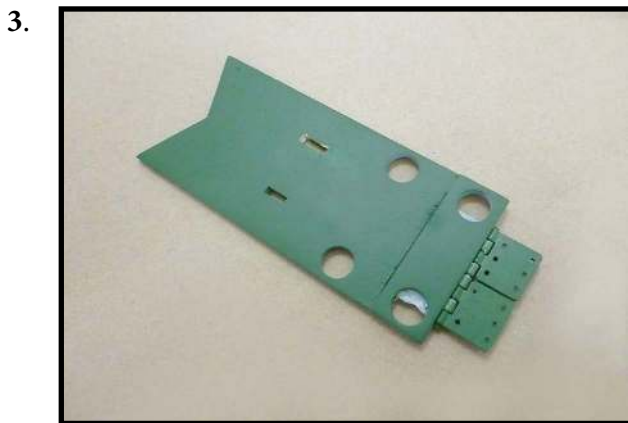
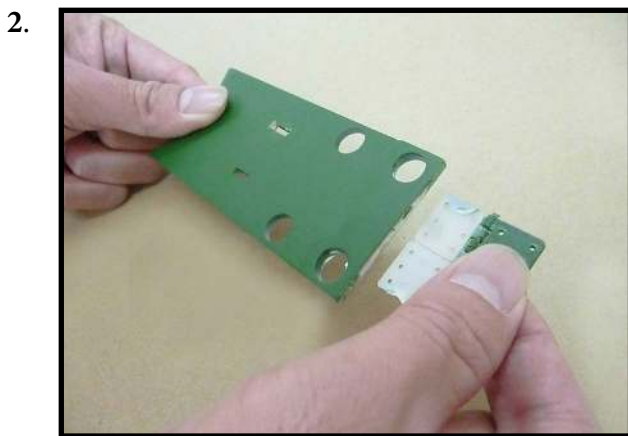

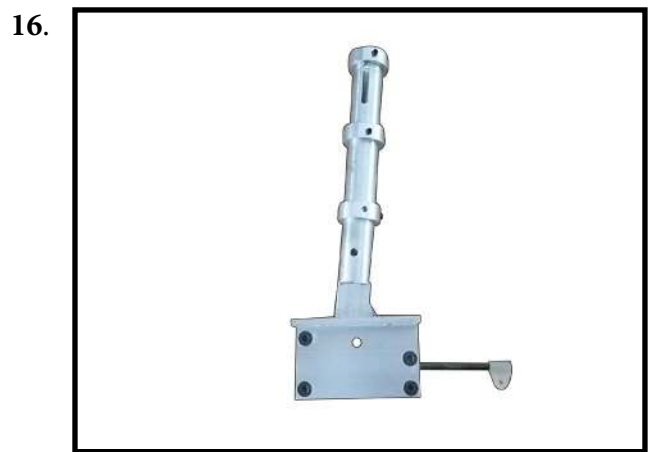
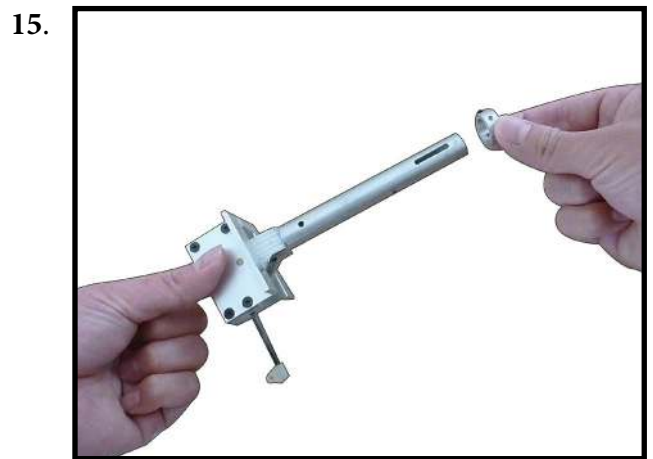
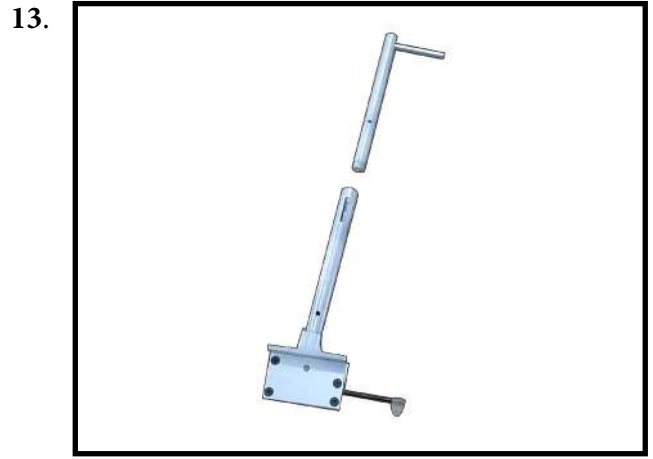
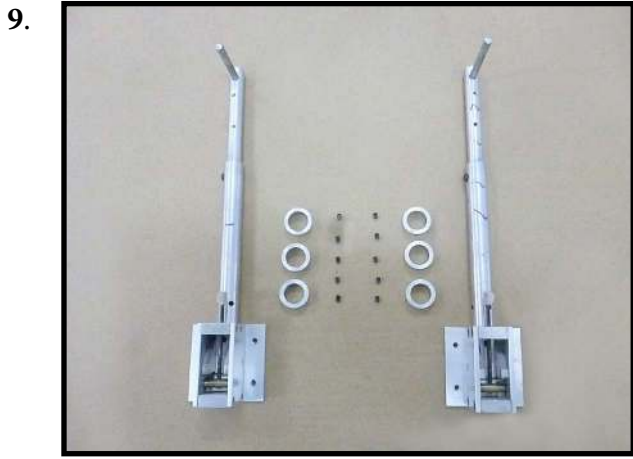

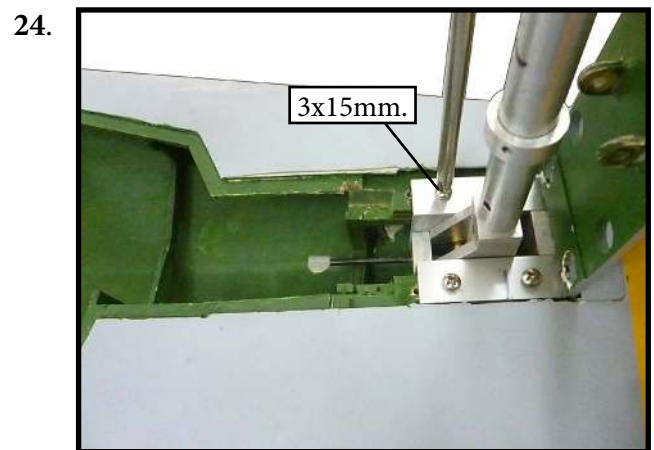
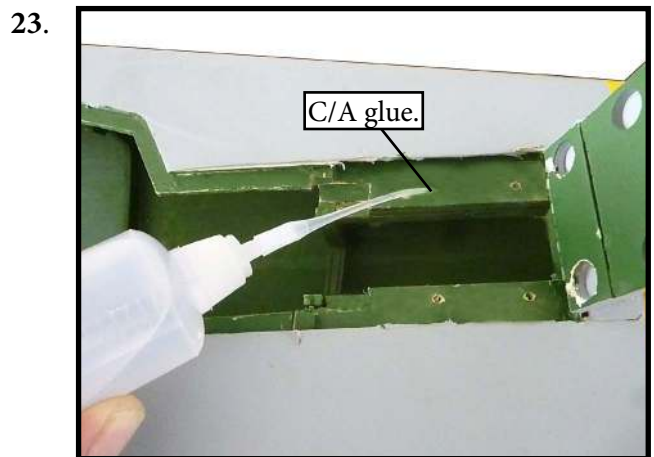
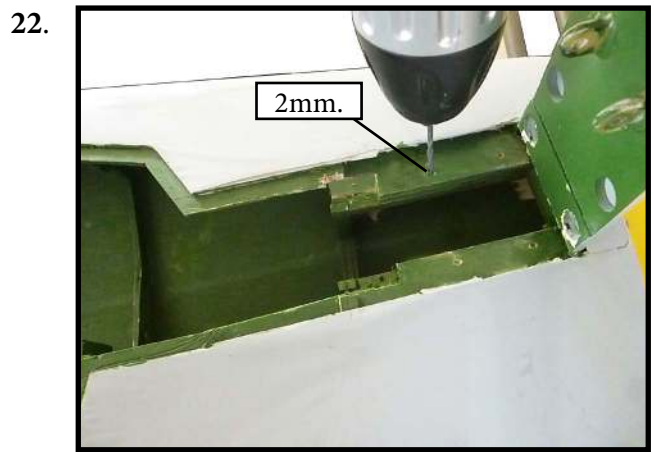
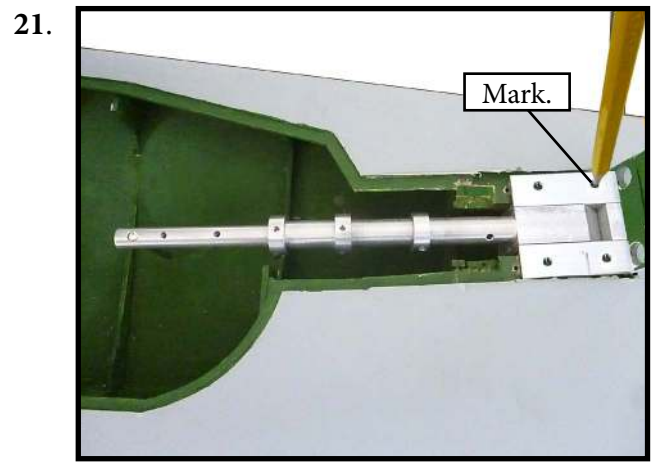
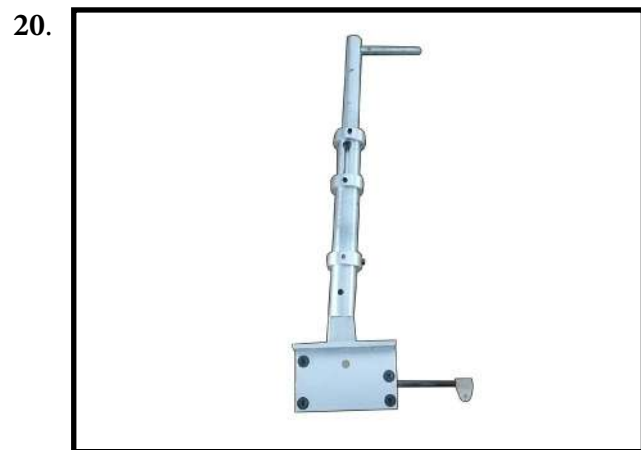
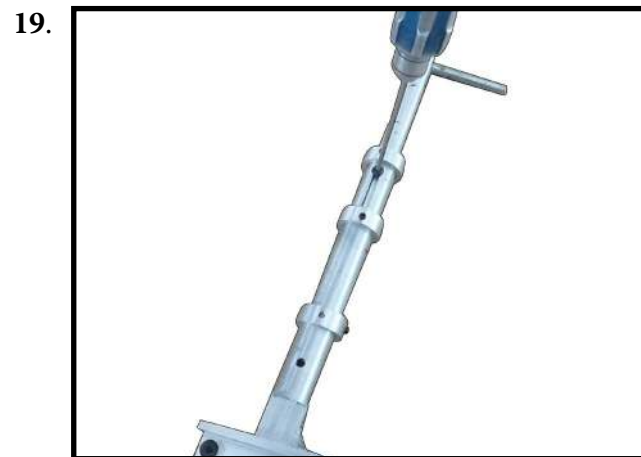
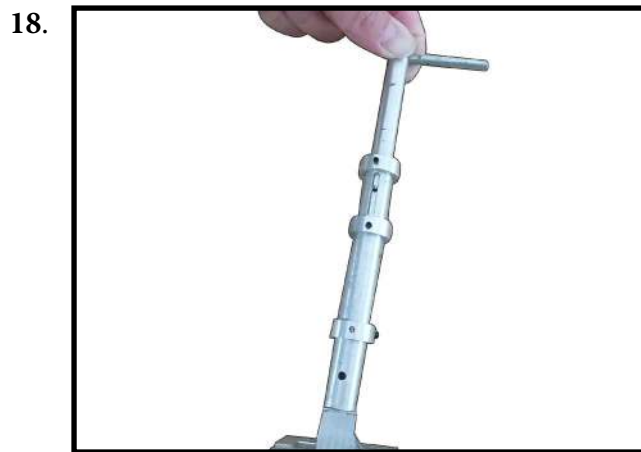
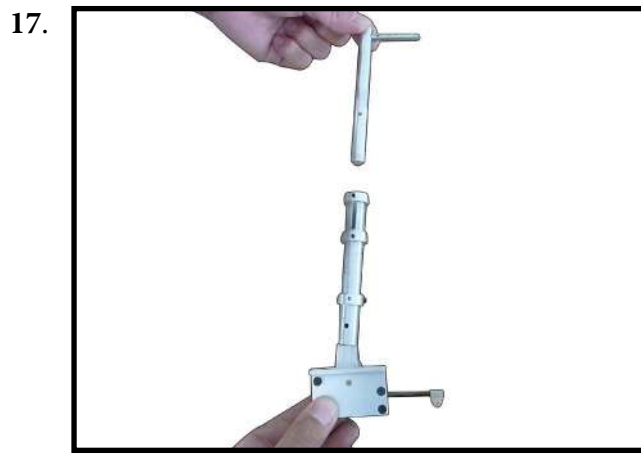

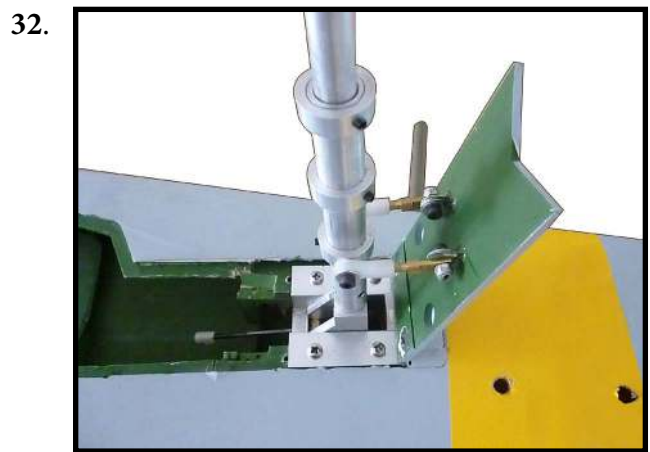
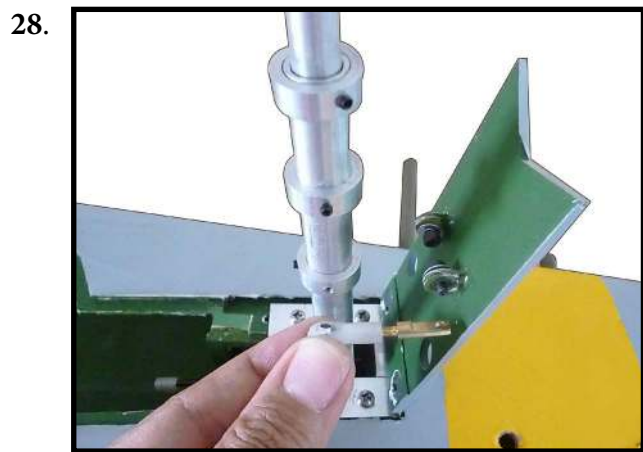
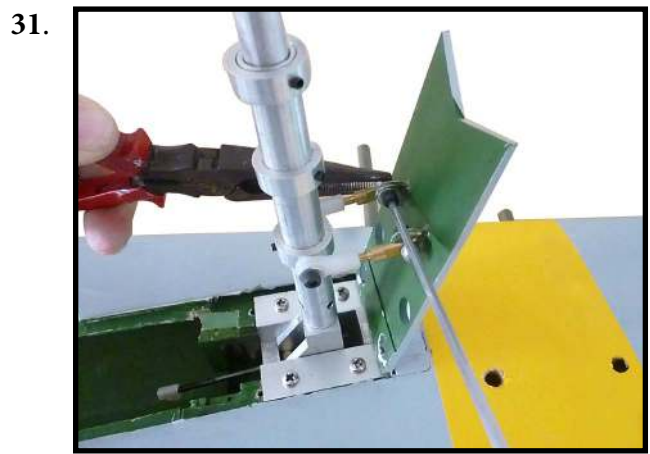
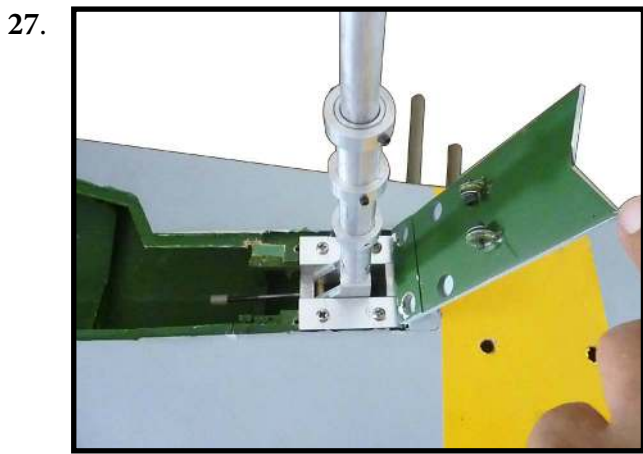
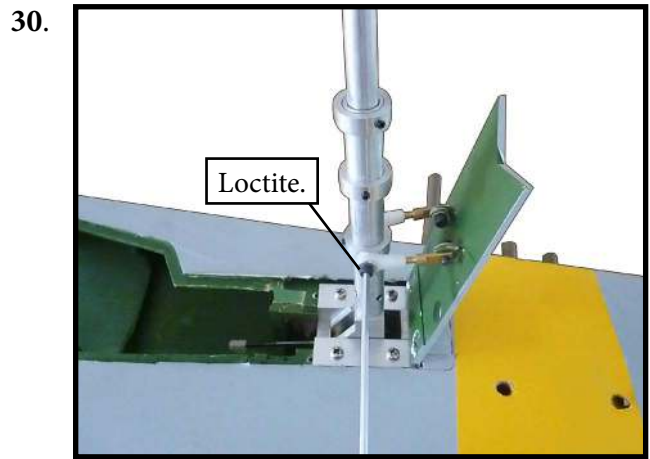
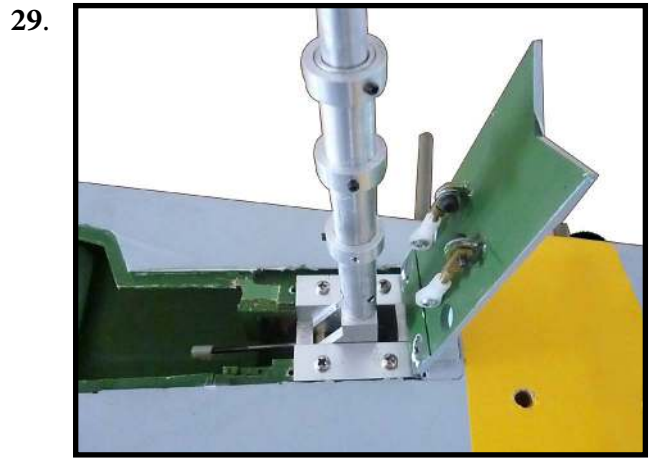
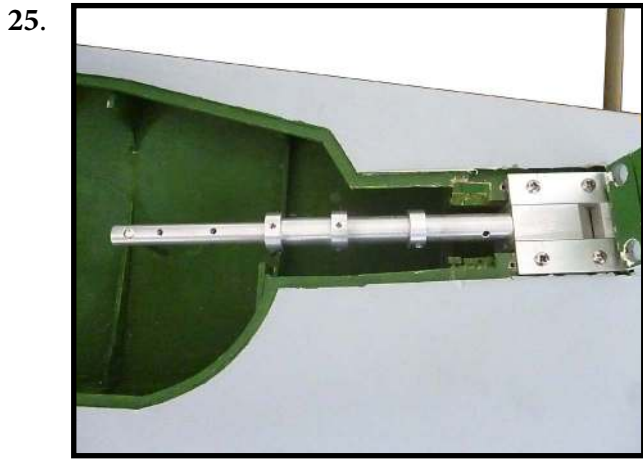

Install servo for Retractable landing gear.

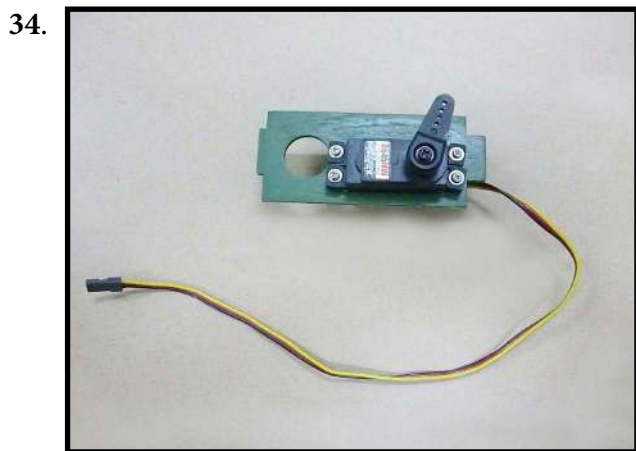
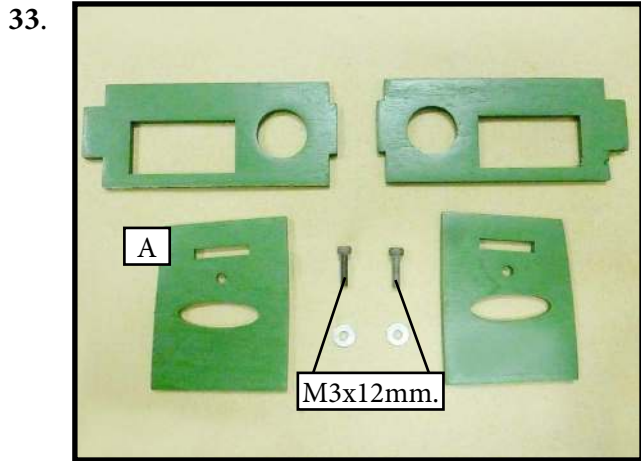

Minimum servo spec.
Torque : 222 oz-in (16 kg-cm) @ 4.8V;
 278 oz-in (20 kg-cm) @ 6.0V

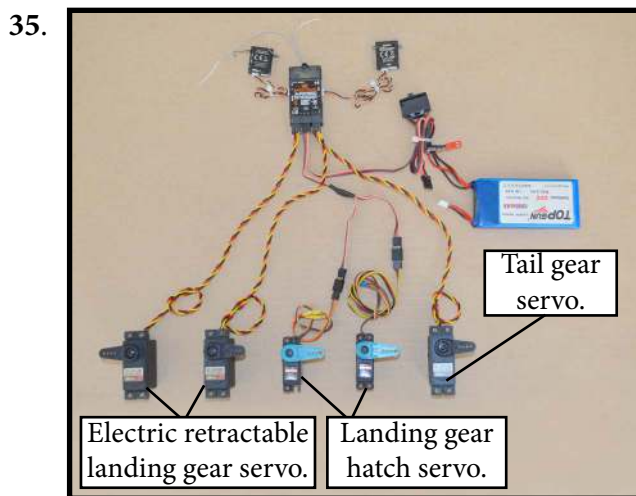

Note: If you clamper down too slow servo speed, servo will not fold when flying.



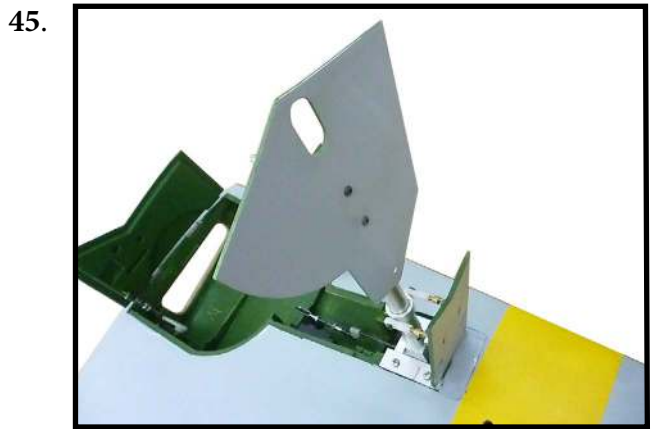
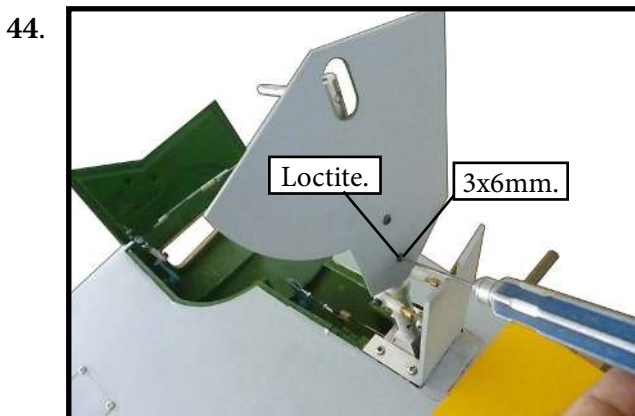
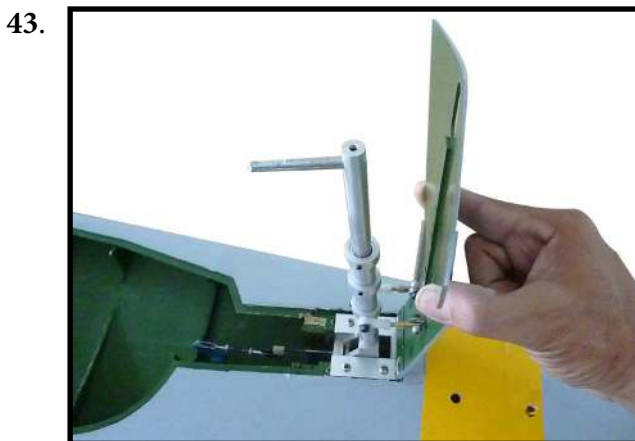
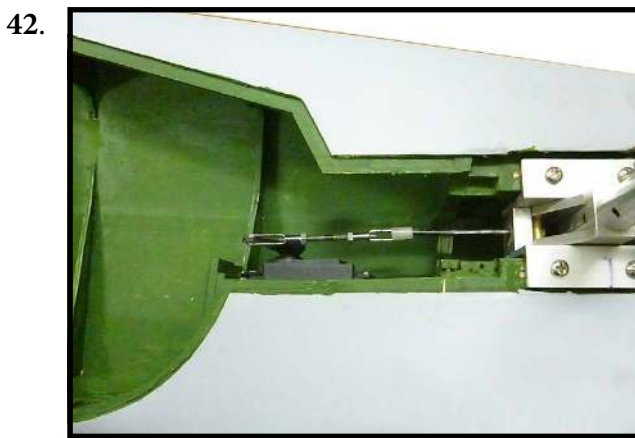
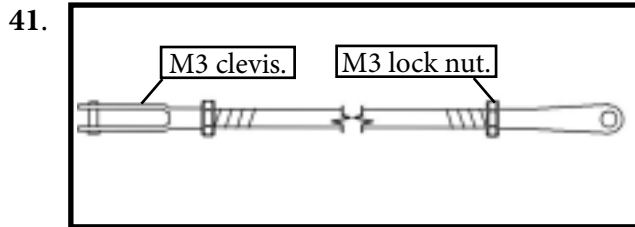
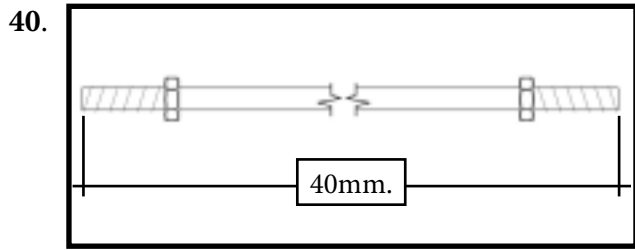

Slide the wheel on the axle, then secure it using the wheel collar.

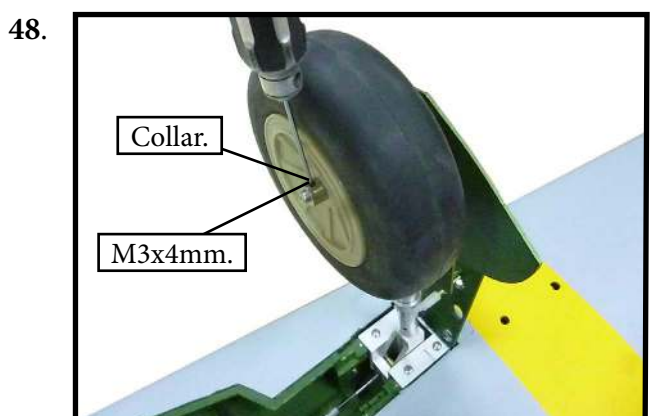
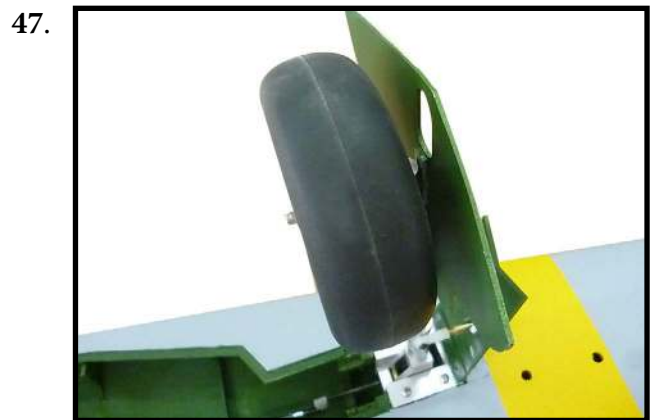
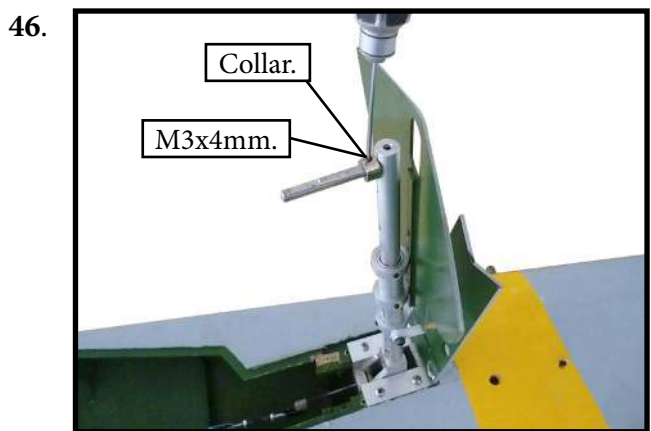

49.

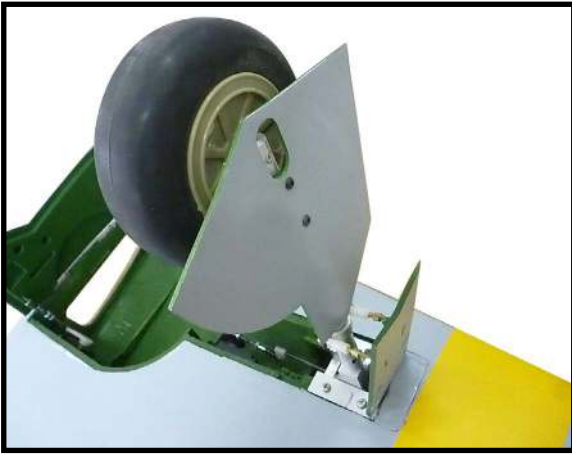

Install the cap on the wing.

50.

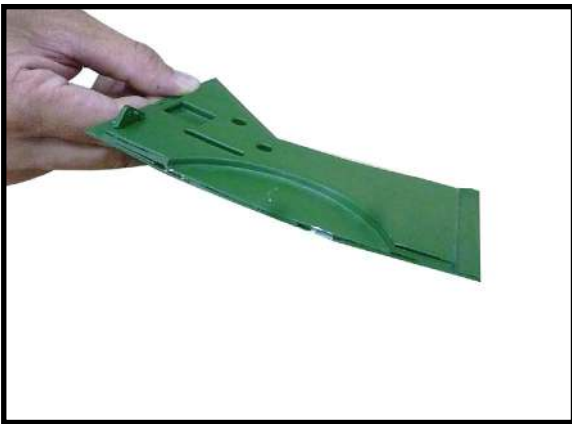

51.

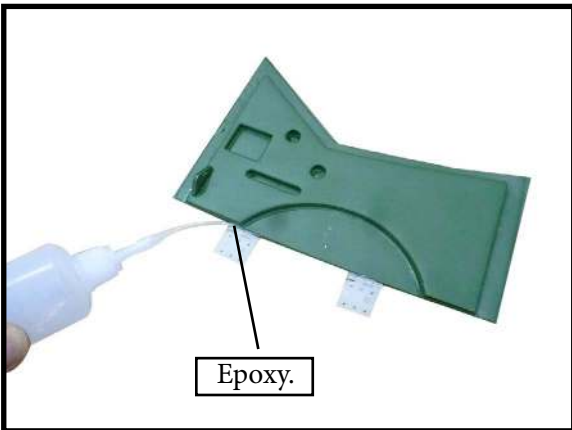

52.



53.

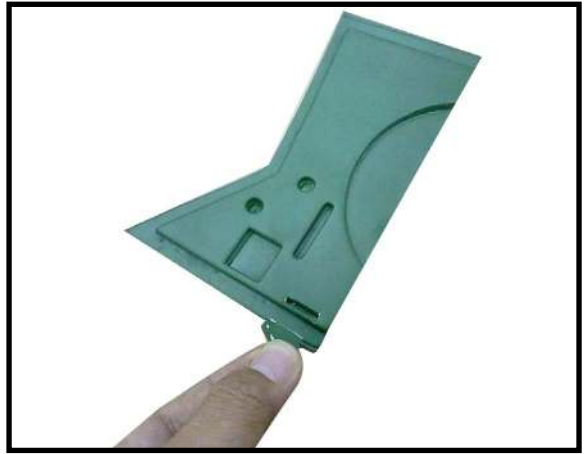

54.

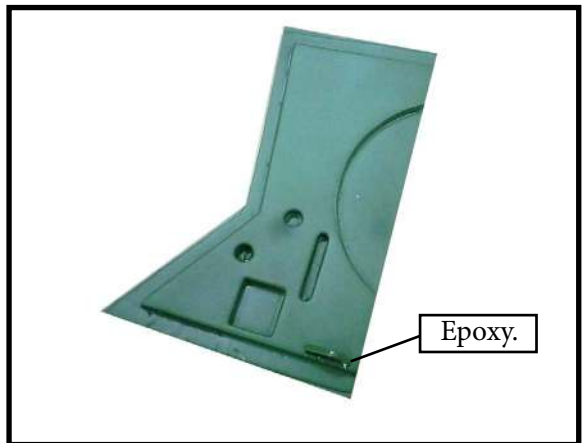

55.

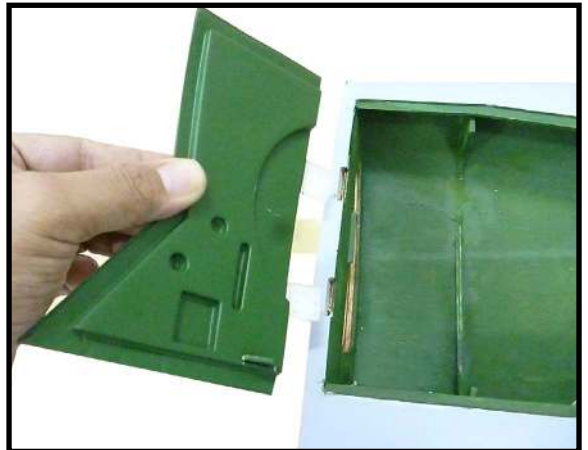

56.

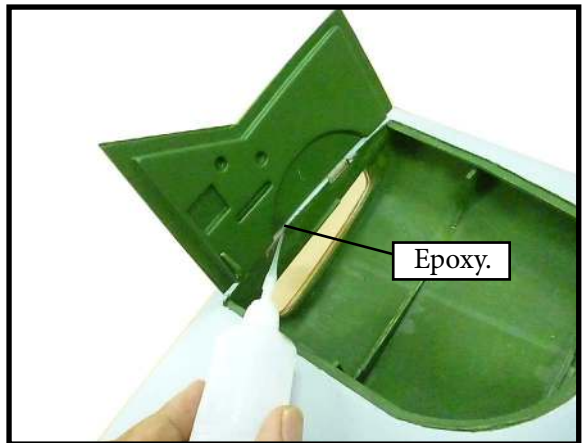

57.



The servo motor should be at least 25mm in size.

58.

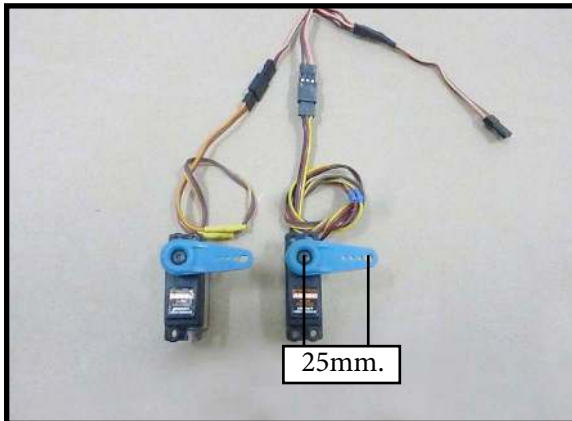

Minimum servo.

Torque : 8.7 oz-in (6.3 kg-cm) @ 6V;
118 oz-in (8.5 kg-cm) @ 8.4V

Encourage the use of servos such as Spektrum.a5060.

Note: The speed of this servo you to be in the slowest mode then you gradually increase to suit the speed ranked.

59.



60.



61.

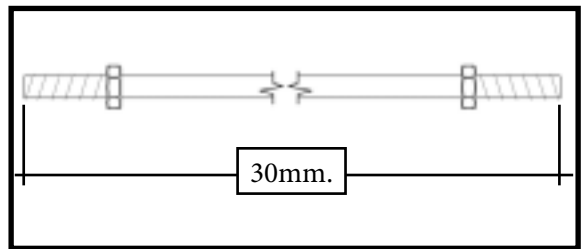

62.

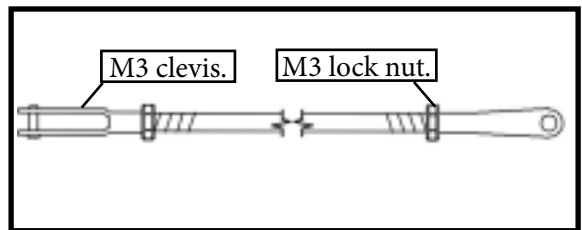

63.



64.





Secure the landing gear doors to the landing gear struts.

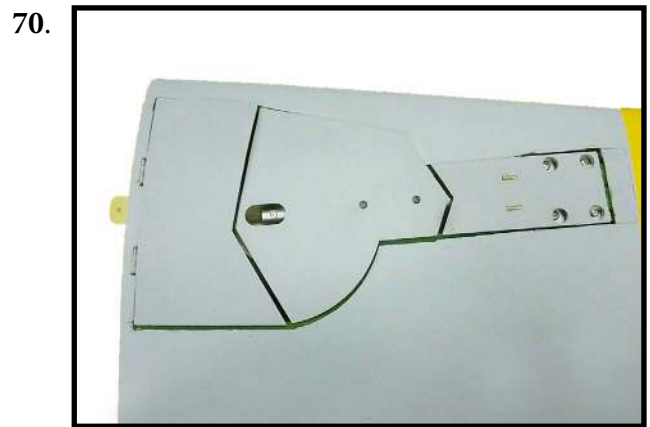
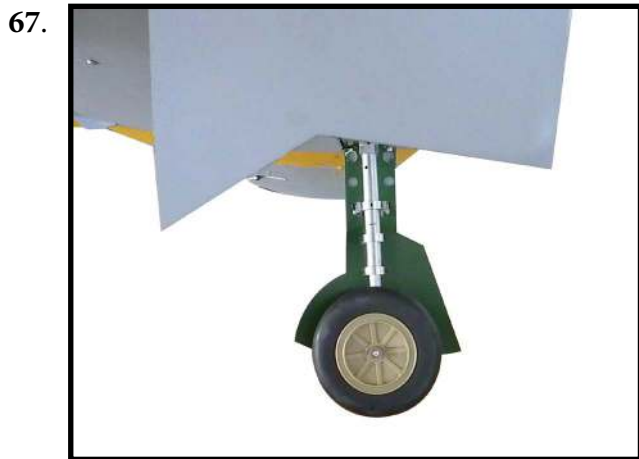
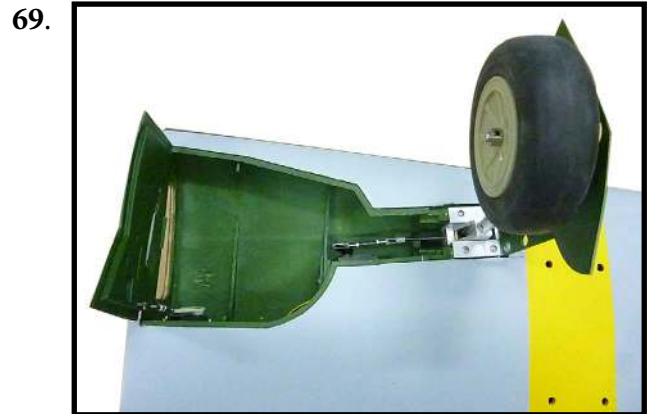

OPTIONAL RETRACTABLE LANDING GEAR.

Electric retractable landing gear is not included in this kit, however it is a very popular add-on as optional. If you want to use retracts in your **GIANT SCALE P-47 RAZORBACK 50-61cc/EP ARF** , we recommend that you buy a good set of electric retracts as the Himark AM07 Main Gear shown as below. These retract units will bolt right into the **GIANT SCALE P-47 RAZORBACK 50-61cc/EP ARF** in place of the standard fixed gear.

Note: The assembly instructions as you make electricity similar to the picture 9 + 11 + 12 +15 +16.



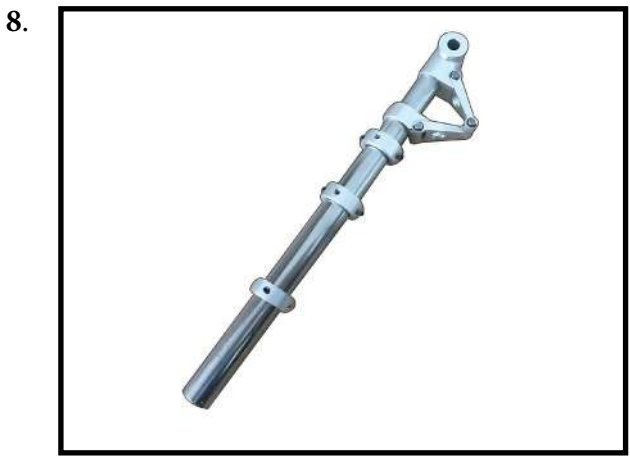
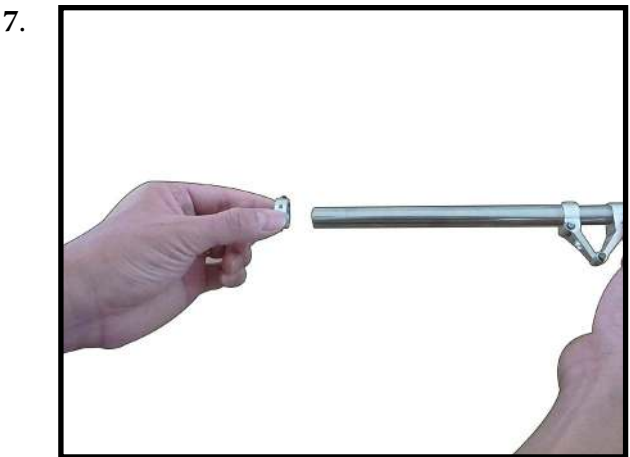
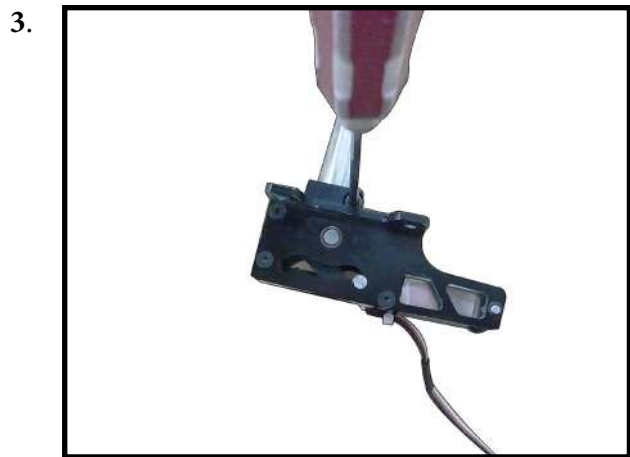
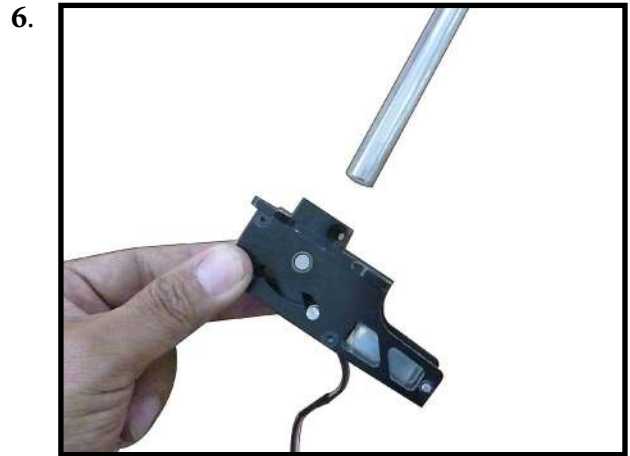
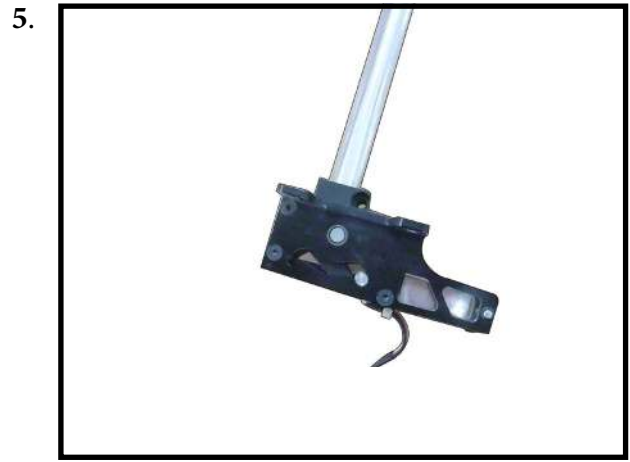
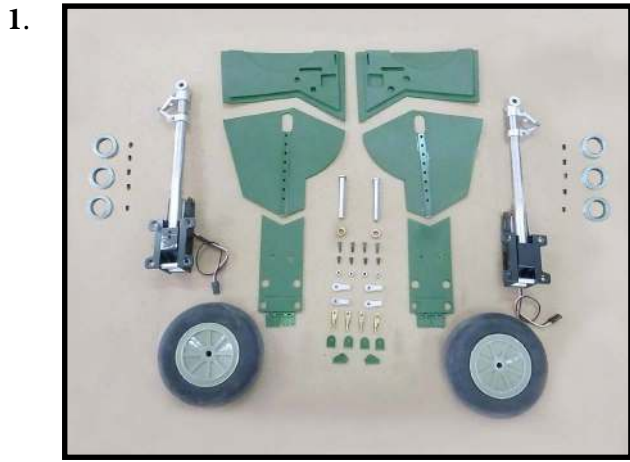

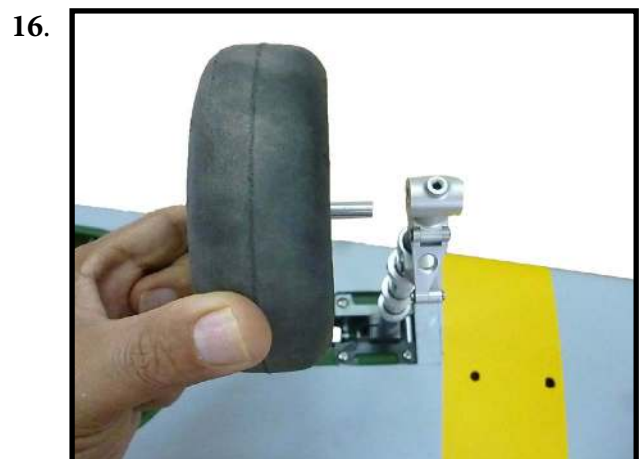
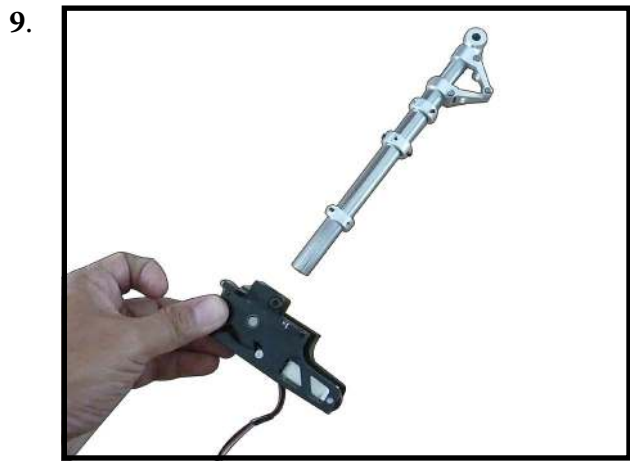

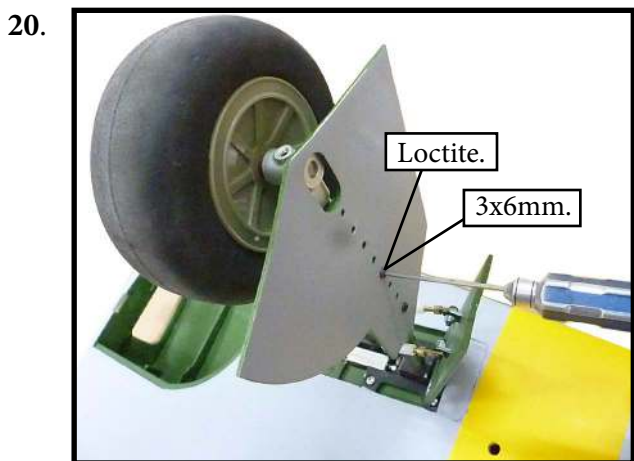
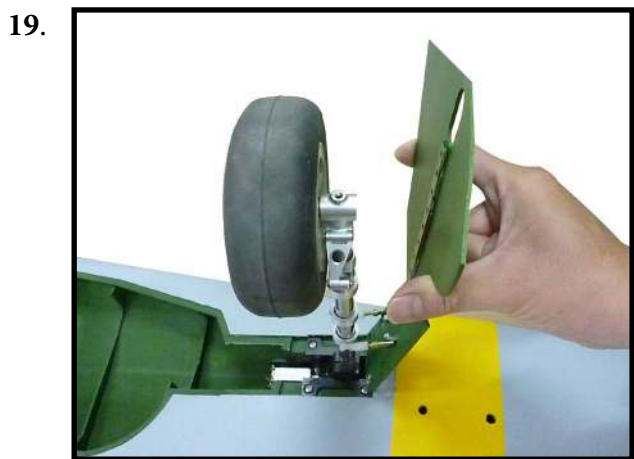
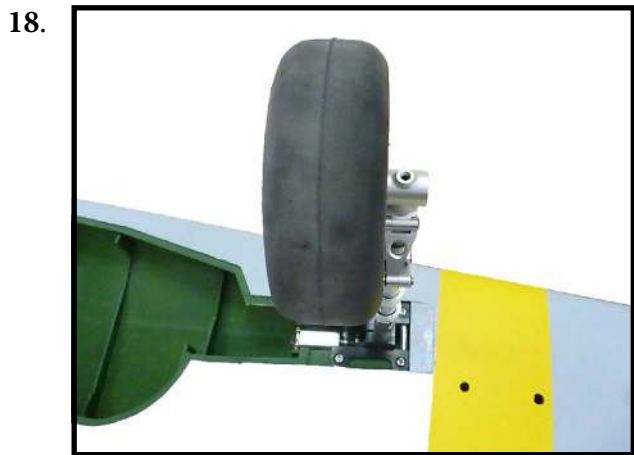
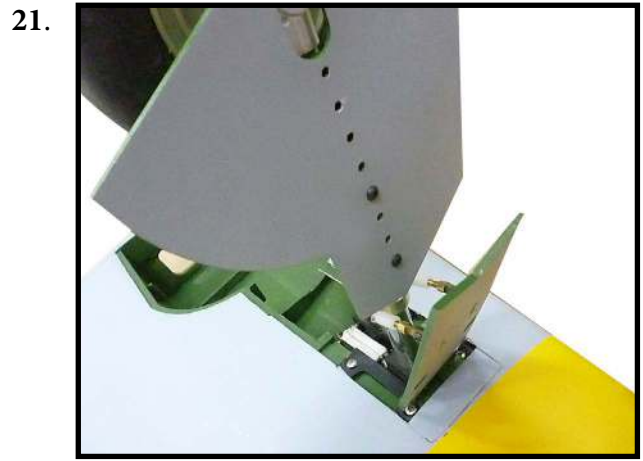
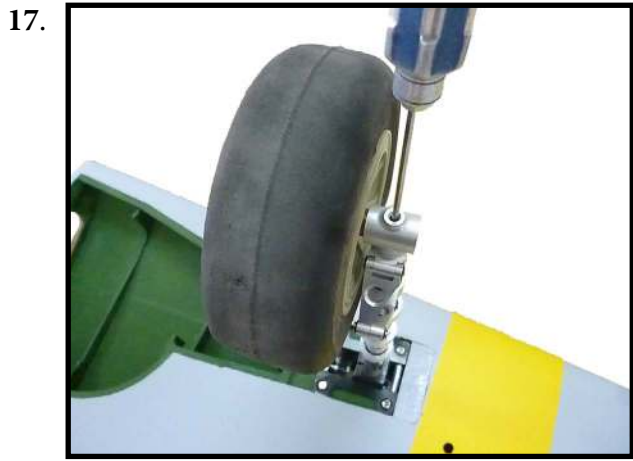

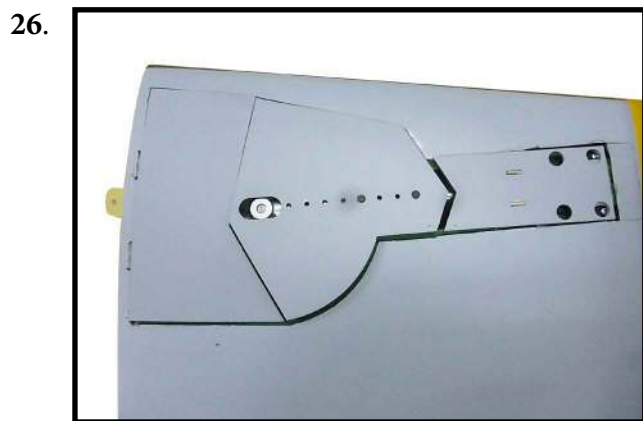
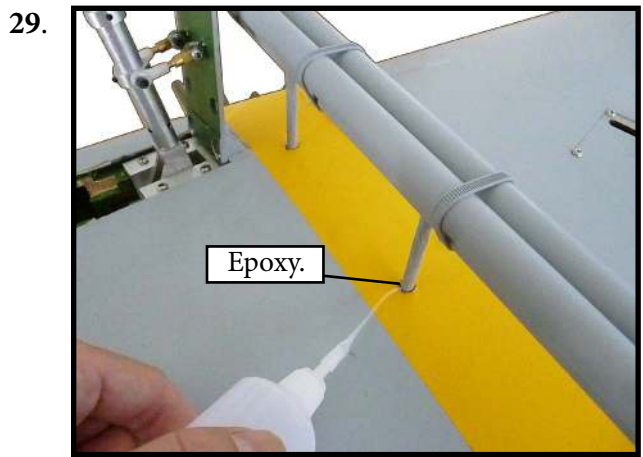
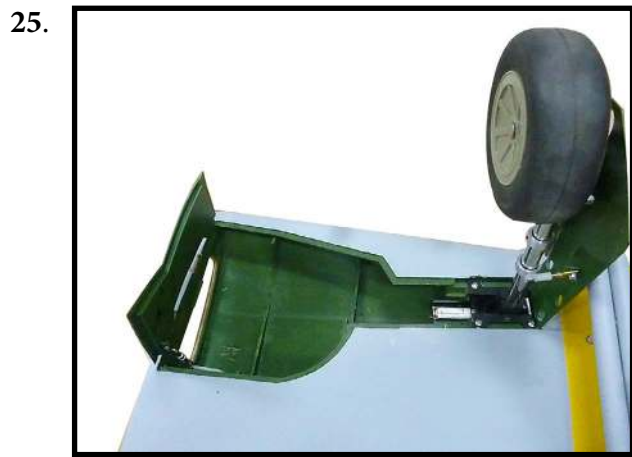

Insert bombs and guns on wings.

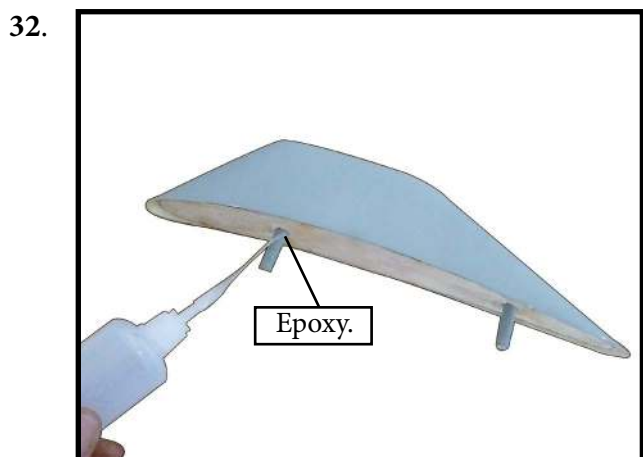
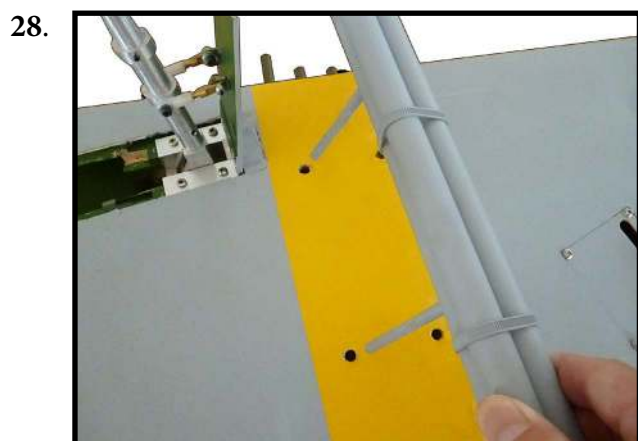
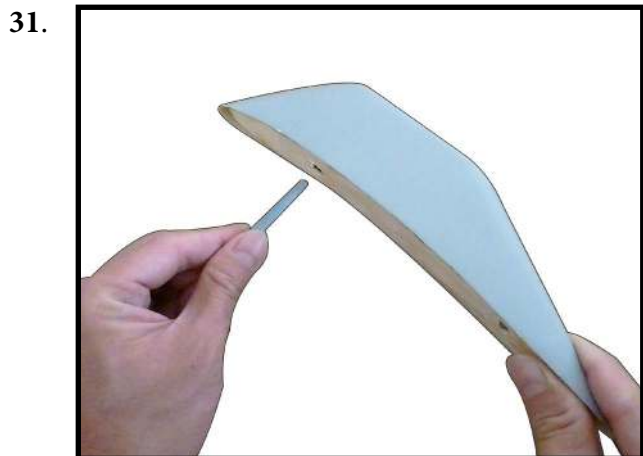
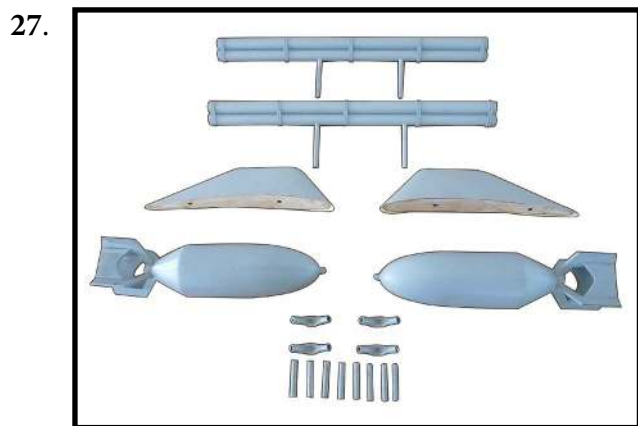

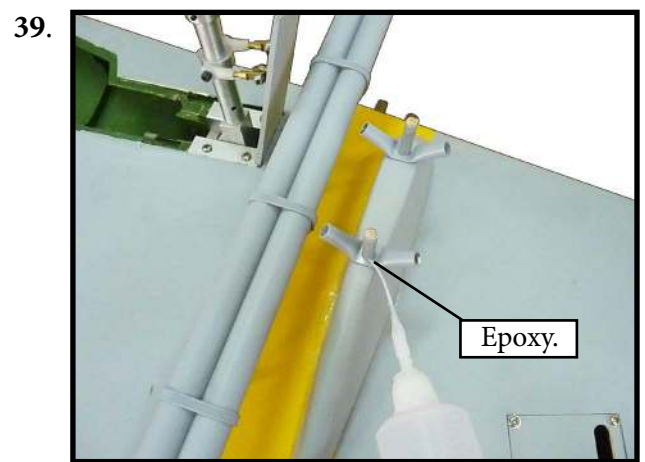
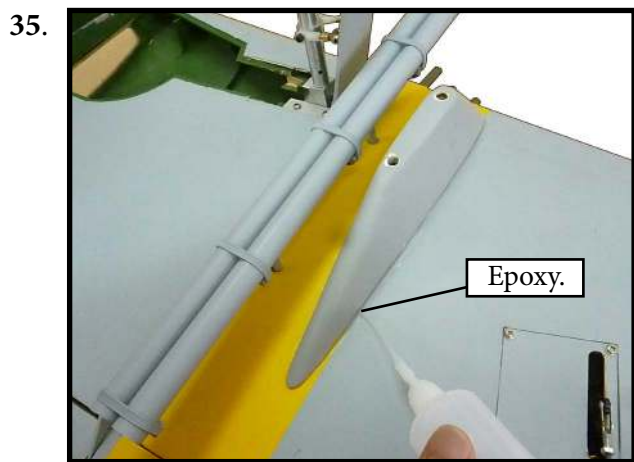
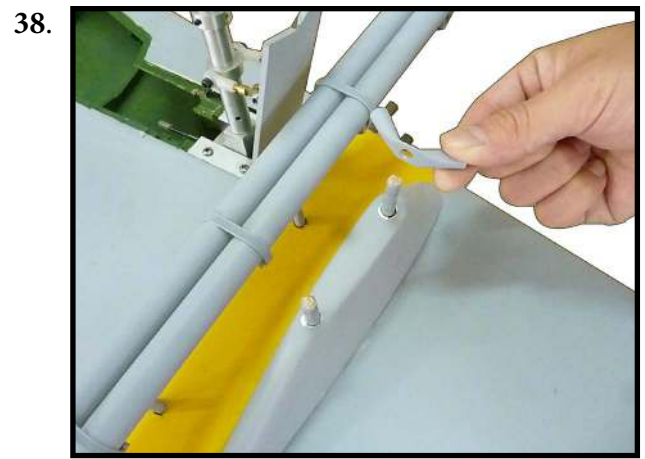
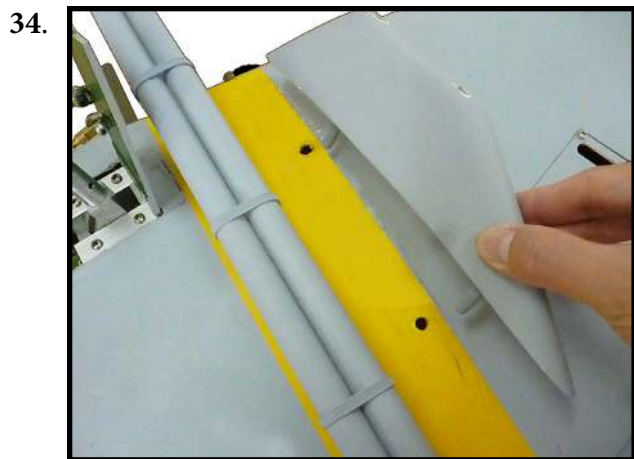
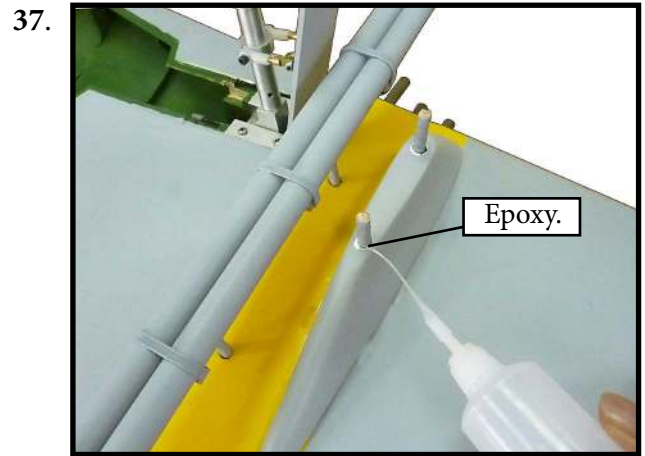
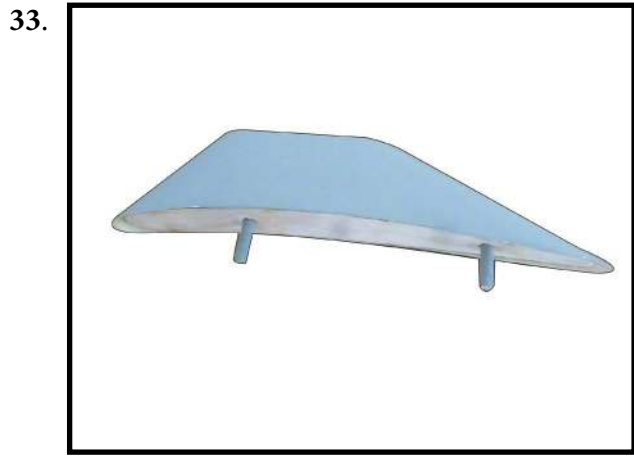

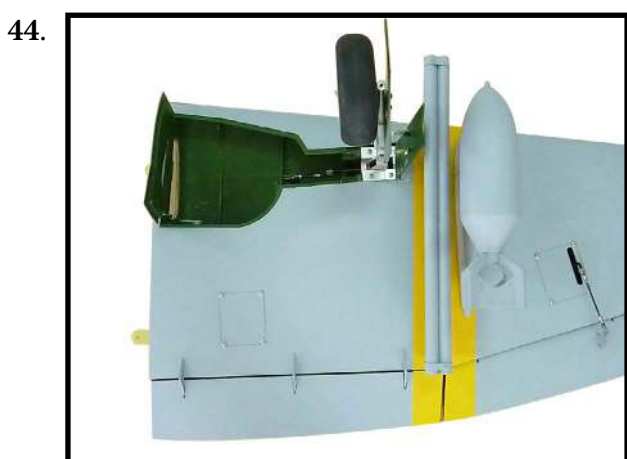
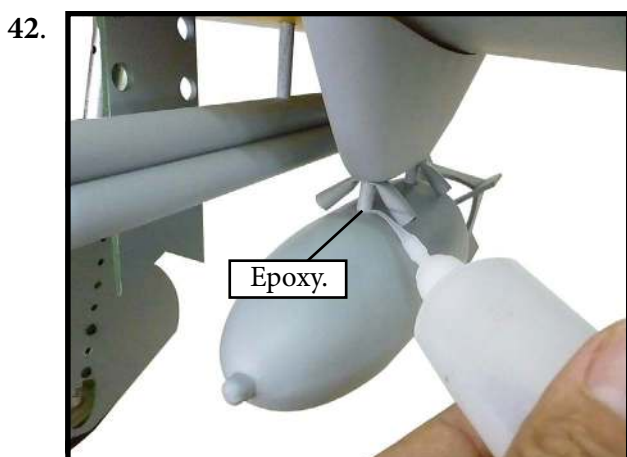

INSTALLING THE FUSEKAGE SERVOS

⚠ Because the size of servos differ, you may need to adjust the size of the precut opening in the mount. The notch in the sides of the mount allow the servo lead to pass through.

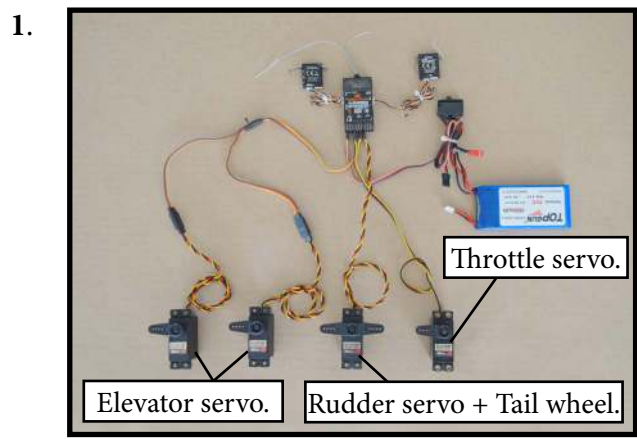

2) Secure the servos with the screws provided with your radio system.

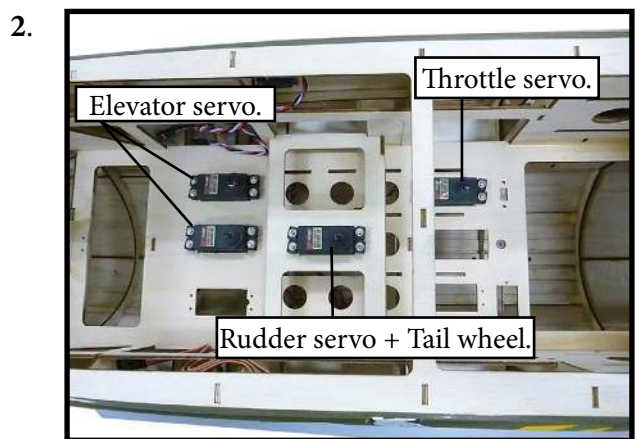

THROTTLE SERVO ARM INSTALLATION

Install adjustable servo connector in the servo arm as same as picture below:

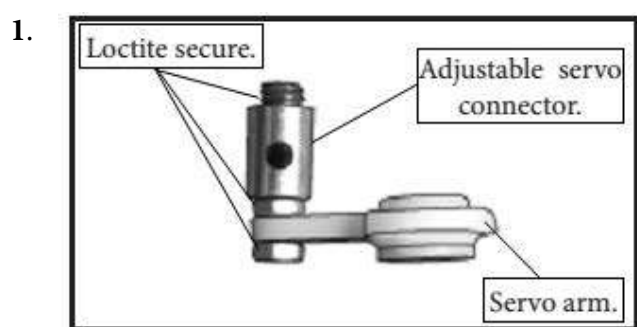

2.

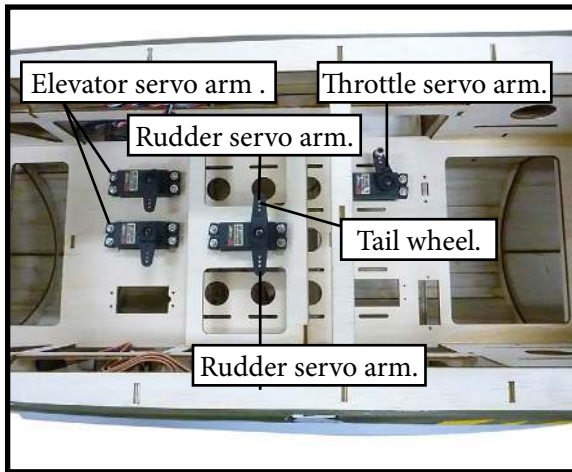

INSTALLING THE RECEIVER SWITCH

Install the switch into the precut hole in the side, in the fuselage.

1.

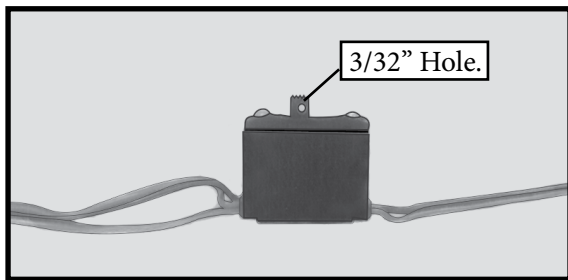

2.

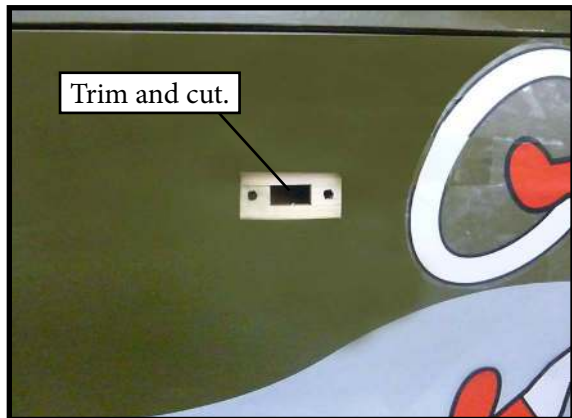

3.

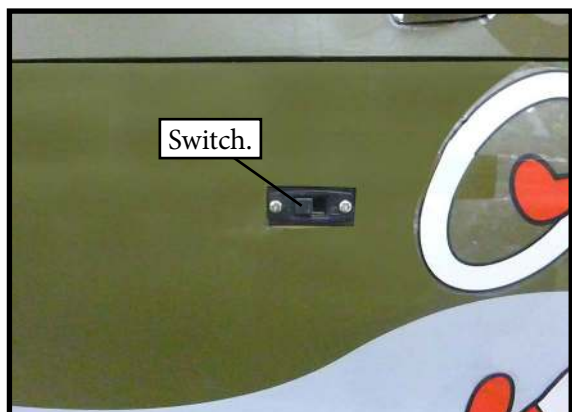

INSTALLING THE ENGINE SWITCH

1.

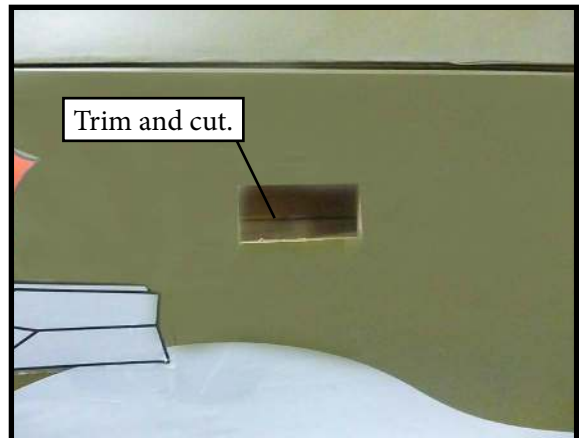

2.

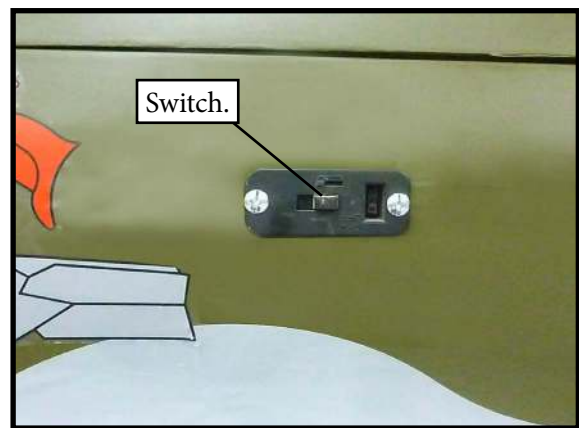

INSTALL SCALE BOMB

Locate items necessary to install.

1.



2.

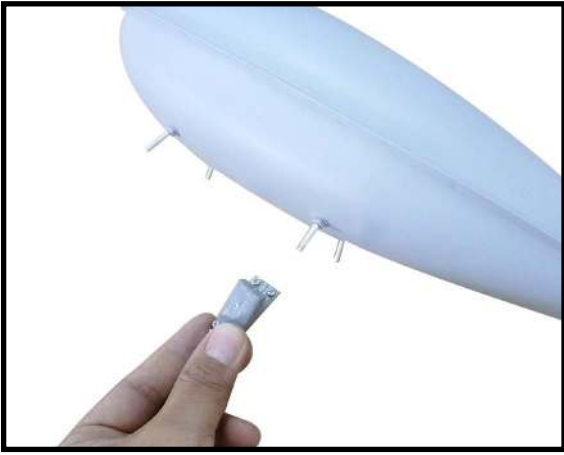

6.



3.



7.



4.



8.



5.

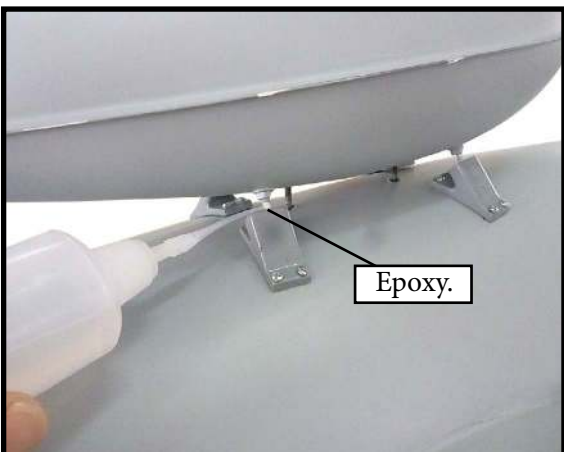

9.



10.



INSTALLING THE STOPPER ASSEMBLY

Using a modeling knife, carefully cut off the rear portion of one of the 3 nylon tubes leaving 1/2" protruding from the rear of the stopper. This will be the fuel pick up tube.

Using a modeling knife, cut one length of silicon fuel line. Connect one end of the line to the weighted fuel pick up and the other end to the nylon pick up tube.

1.

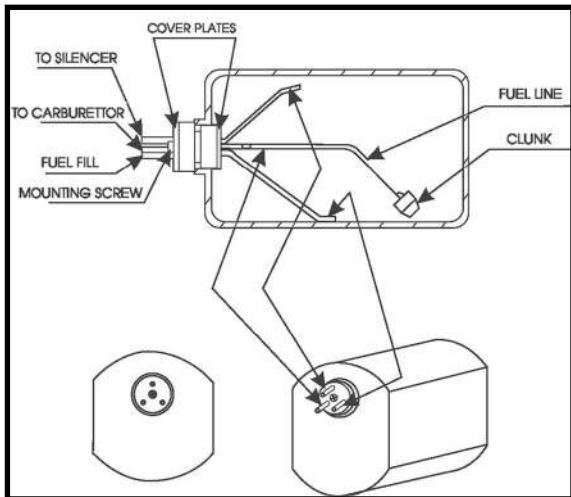

2.

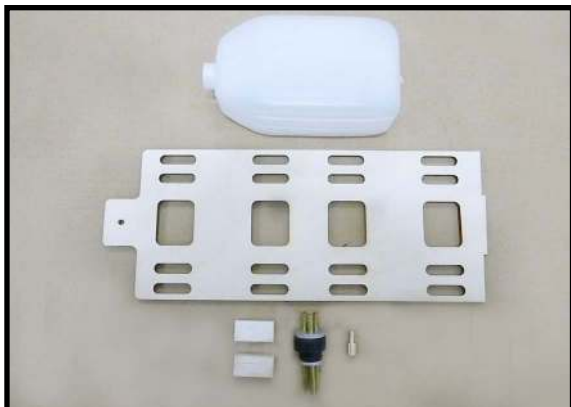

3.

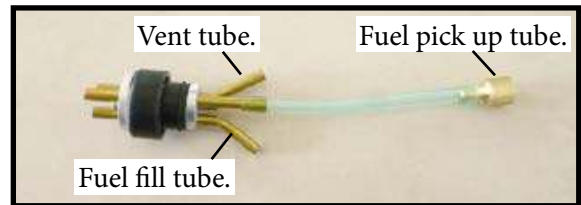

Carefully bend the second nylon tube up at a 45° angle. This tube is the vent tube.

Test fit the stopper assembly into the tank. It may be necessary to remove some of the flashing around the tank opening using a modeling knife. If flashing is present, make sure none falls into the tank.

With the stopper assembly in place, the weighted pick-up should rest away from the rear of the tank and move freely inside the tank. The top of the vent tube should rest just below the top of the tank. It should not touch the top of the tank.

When satisfied with the alignment of the stopper assembly tighten the 3 x 20mm machine screw until the rubber stopper expands and seals the tank opening. Do not overtighten the assembly as this could cause the tank to split.

FUEL TANK INSTALLATION

1.



! You should mark which tube is the vent and which is the fuel pickup when you attach fuel tubing to the tubes in the stopper. Once the tank is installed inside the fuselage, it may be difficult to determine which is which.

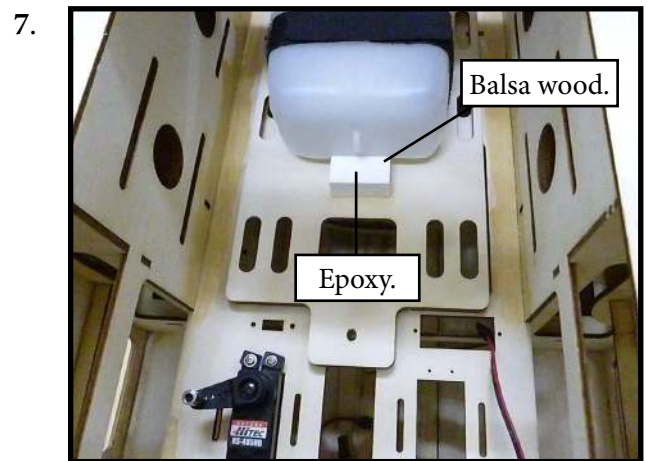
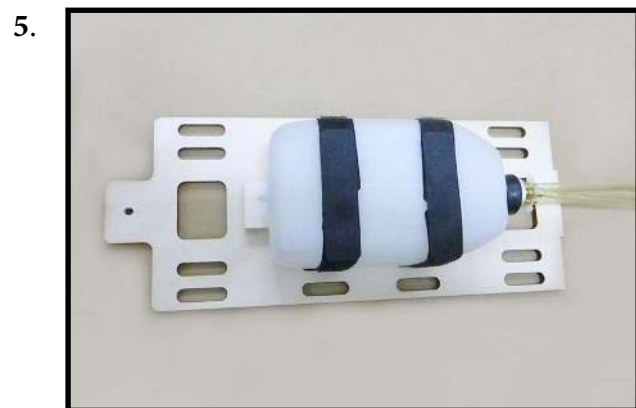
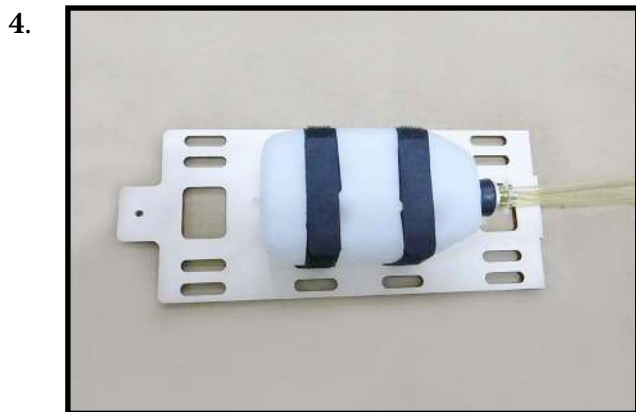
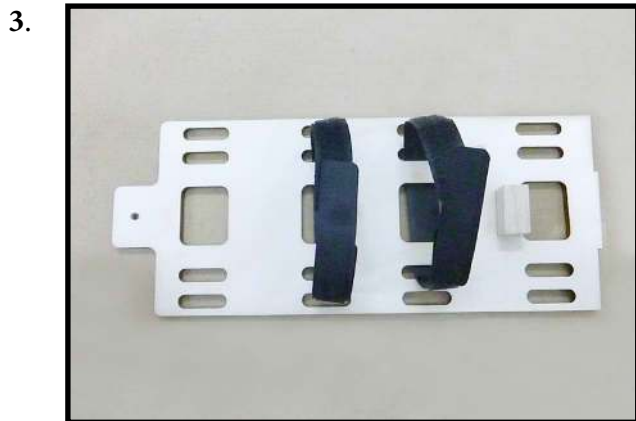
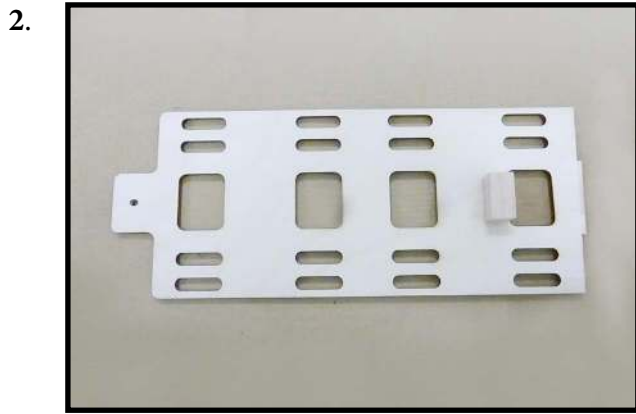

Slide the fuel tank into the fuselage. Guide the lines from the tank through the hole in the firewall.

10.

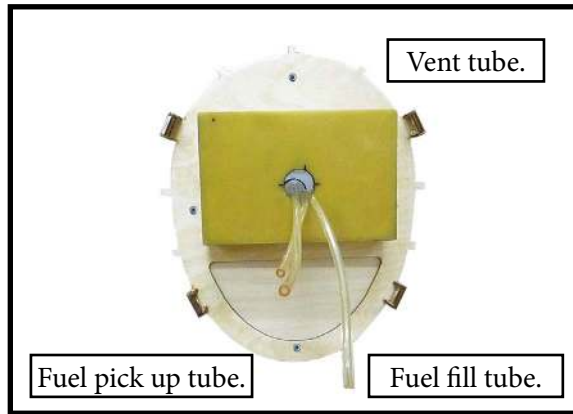

Connect the lines from the tank to the engine and muffler. The vent line will connect to the muffler and the line from the clunk to the carburetor.

! *Blow through one of the lines to ensure the fuel lines have not become kinked inside the fuel tank compartment. Air should flow through easily.*

MOUNTING THE ENGINE

Please see below pictures.

1.

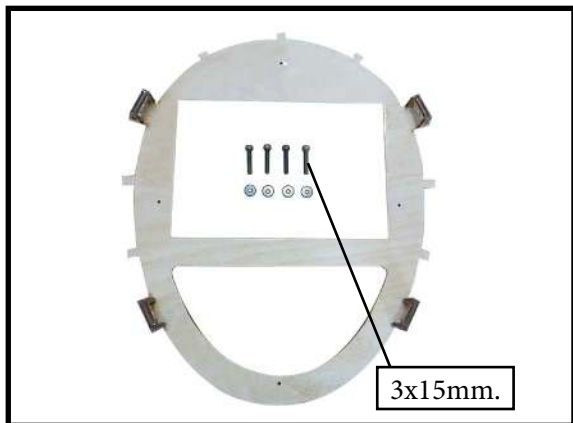

2.

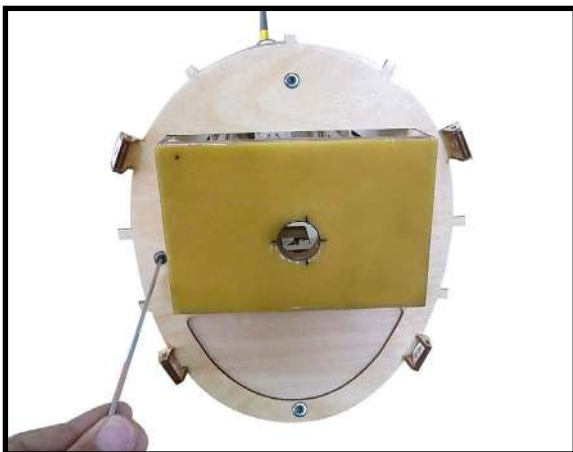

3.

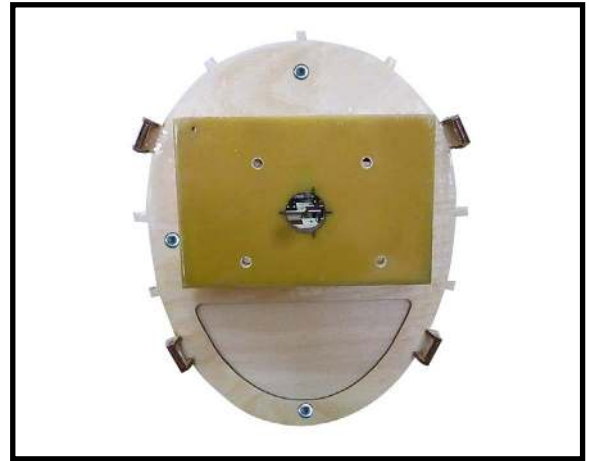

4.

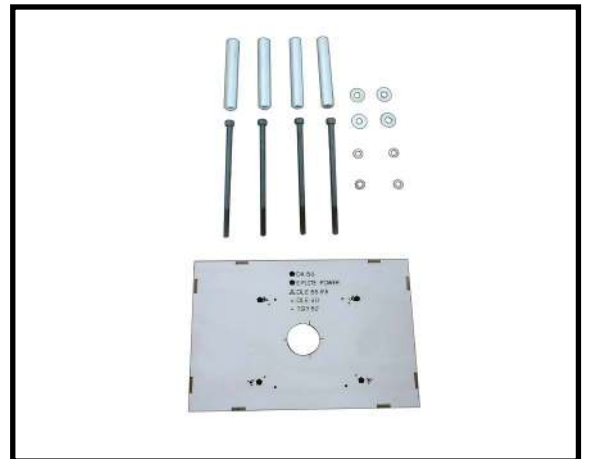

Locate the engine mounting in position on the firewall. Use a 2.5mm drill bit to drill the holes necessary to mount your particular motor choice.

5.

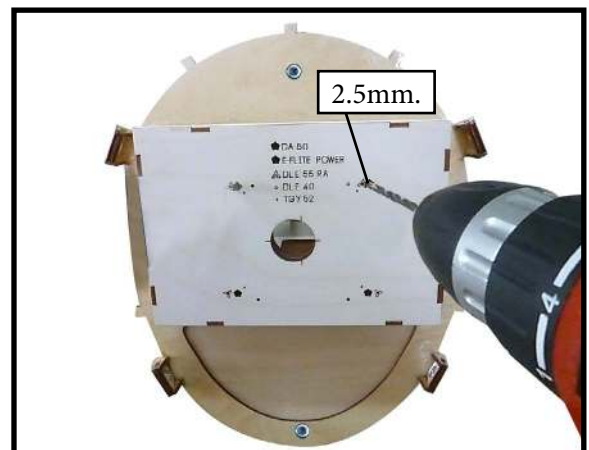

6.



10.

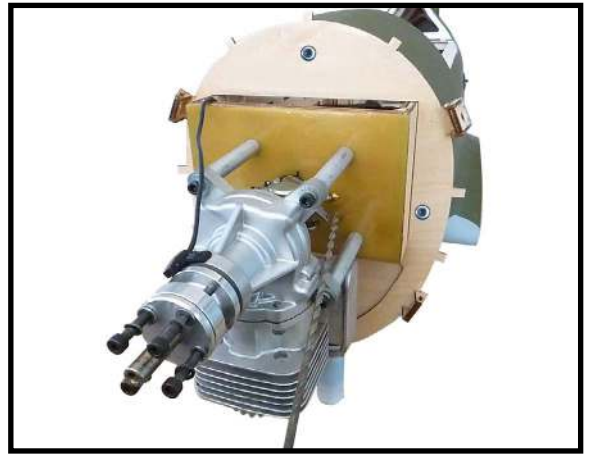

7.

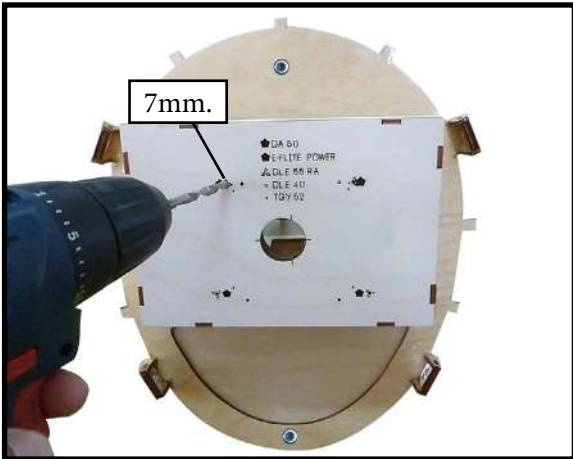

11.

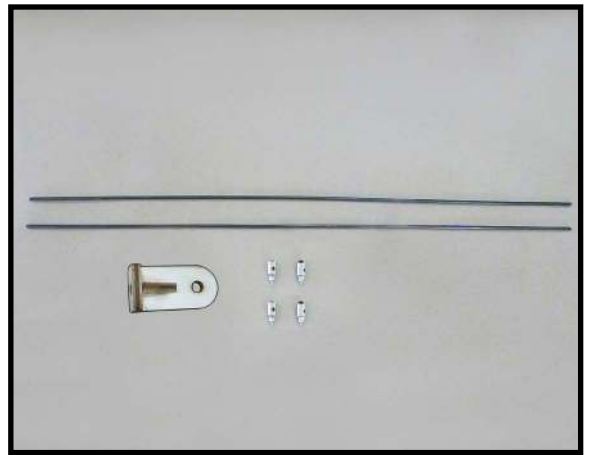

8.

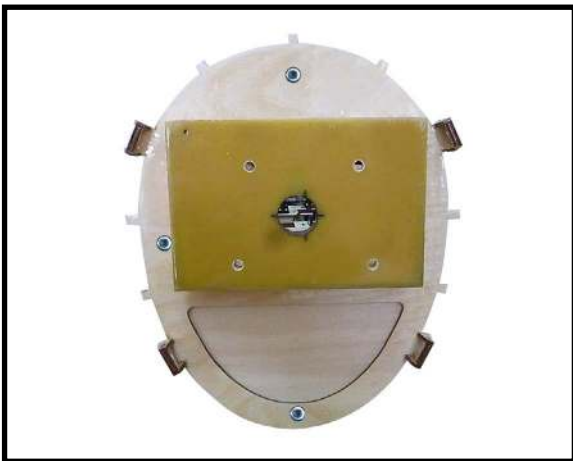

12.



9.



13.



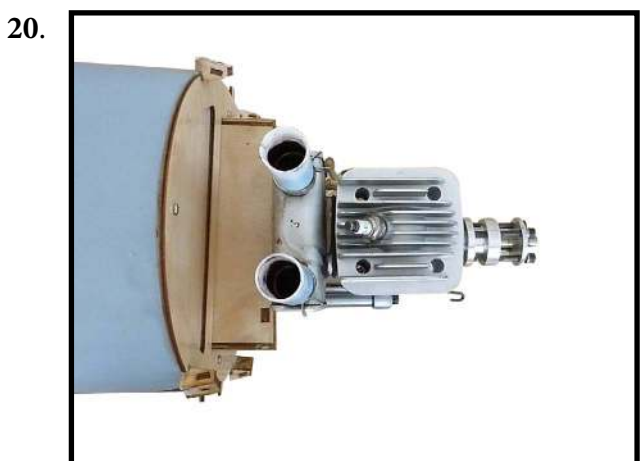
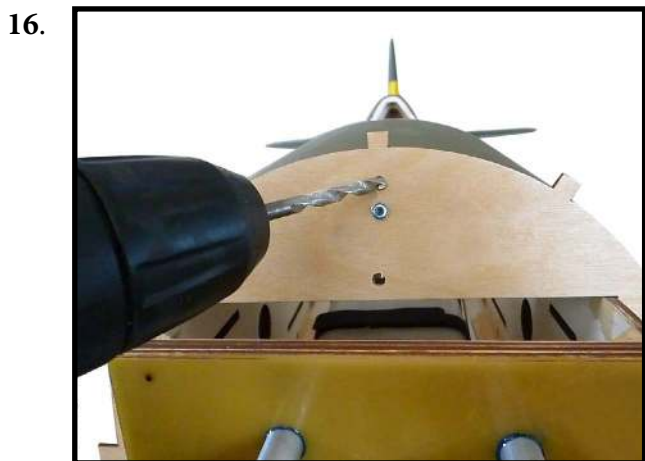
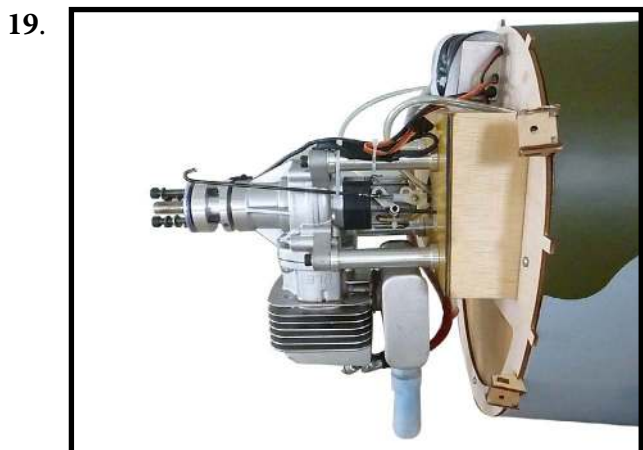
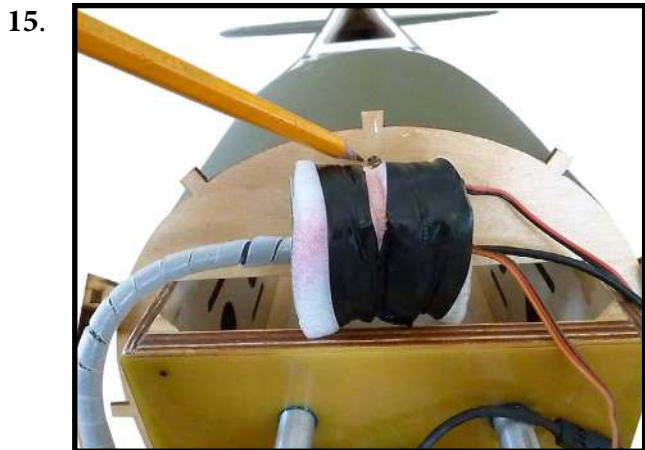
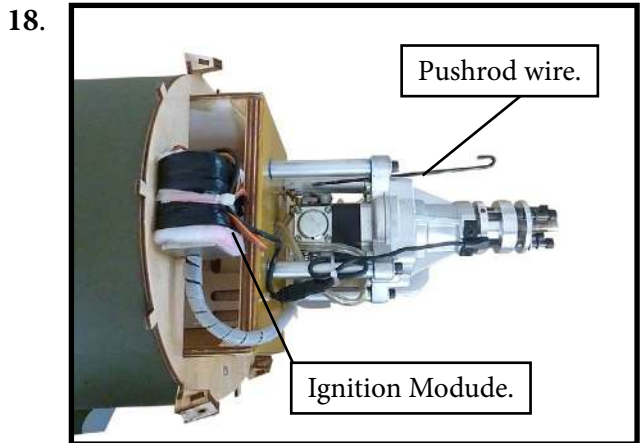
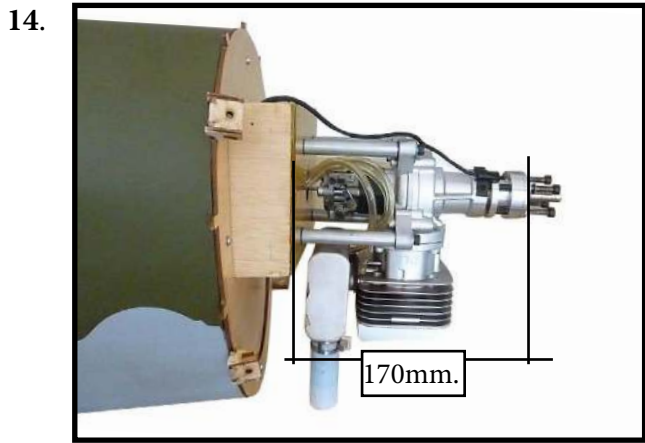

22.

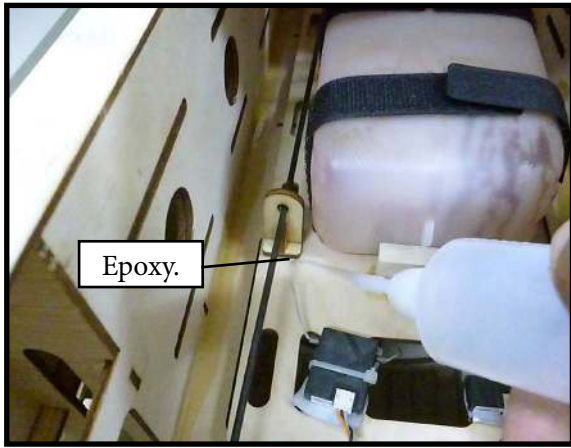

Use medium CA to glue the pushrod standoff to the inside of the fuselage and the pushrod tube.

23.



Reinstall the servo horn by sliding the connector over the pushrod wire. Center the throttle stick and trim and install the servo horn perpendicular to the servo center line.

24.



Move the throttle stick to the closed position and move the carburetor to closed. Use a 2.5mm hex wrench to tighten the screw that secures the throttle pushrod wire. Make sure to use threadlock on the screw so it does not vibrate loose.

COWLING

Please see below pictures.

1.

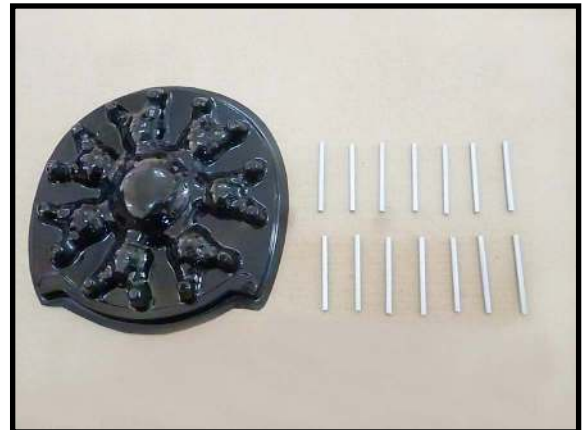

2.



3.



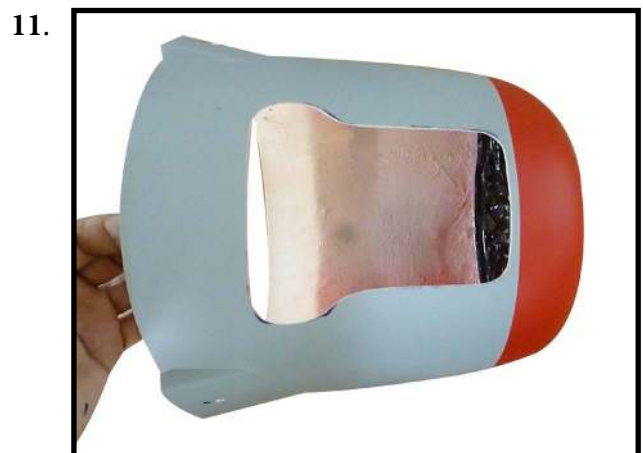
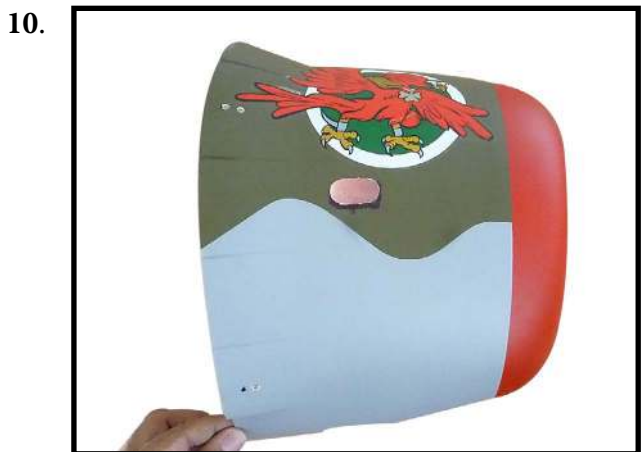

Tape the cowl to the fuselage using low-tack tape.

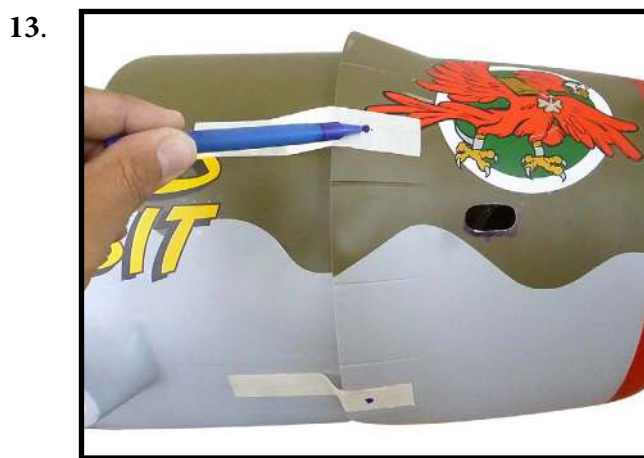
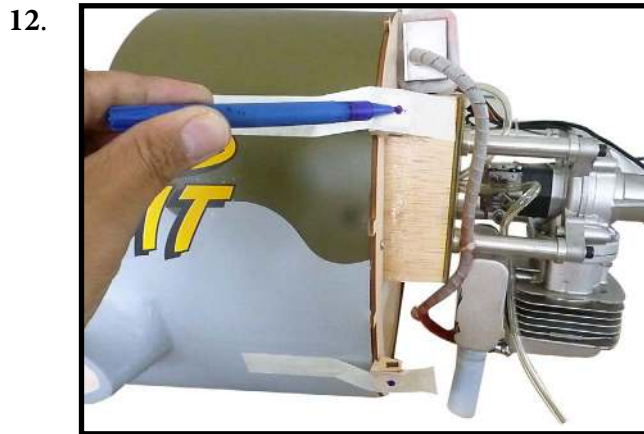

Use a drill and drill bit to drill the holes for the cowl mounting screws. Make sure the cowl position is correct before drilling each hole.

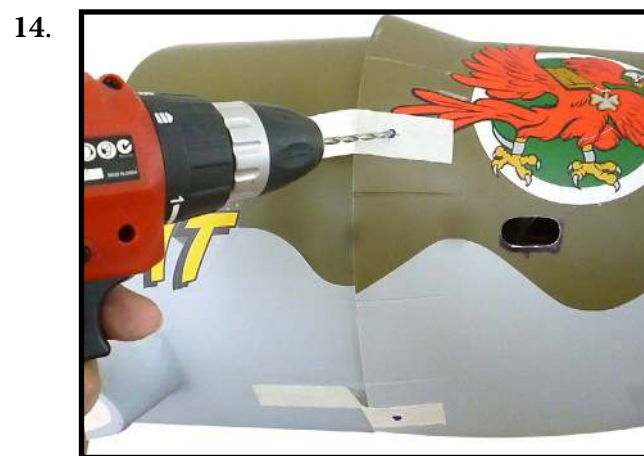

Install the muffler and muffler extension onto the engine and make the cutout in the cowl for muffler clearance. Connect the fuel and pressure lines to the carburetor, muffler and fuel filter valve. Secure the cowl to fuselage using the M3x10mm socket head screws. Putting a small length of silicon fuel tube under the head of the screw helps with vibration.

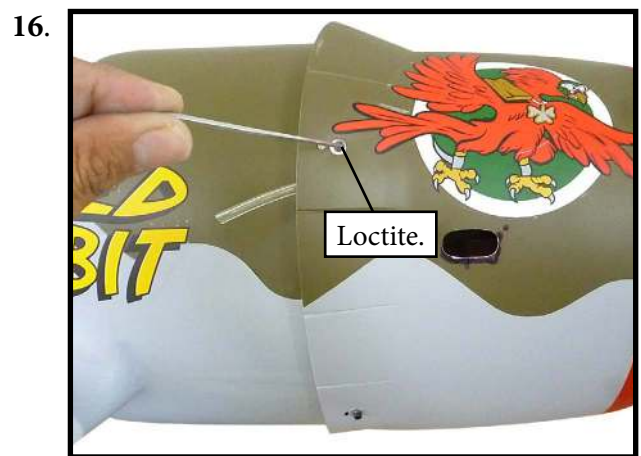
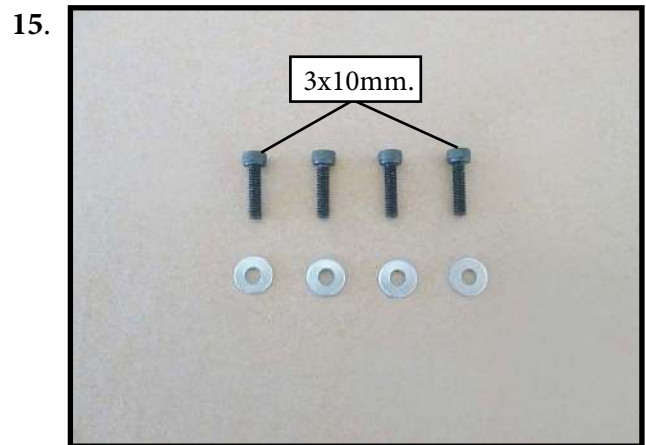

18.



19.



20.



ELECTRIC POWER CONVERSION

Locate the items necessary to install the electric power conversion included with your model.

1.

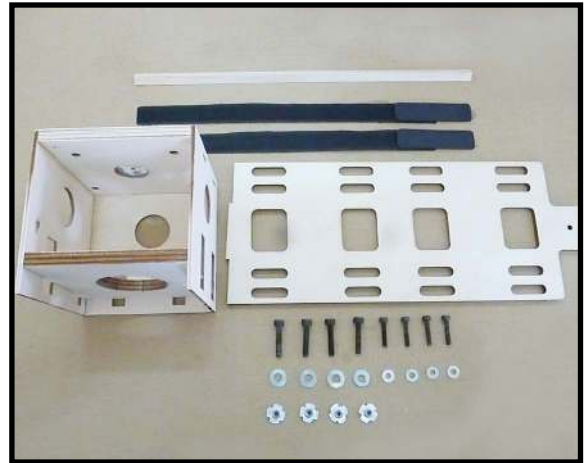

Recommend the items necessary to install the electric power conversion parts included with your model.

- **Motor: 360 - 6000 Watts**
- **Propeller: 24x10 ~ 25x12**
- **ESC: 160A - 200A**
- **12S Lipo**

Attach the electric motor box to the firewall centered with the cross lines drawn on the electric motor box and firewall. Using M5x30mm to secure the motor box to the firewall. Please see pictures below.

2.



Attach the motor mount to the front of the electric motor box using four 5mm blind nut, four M5x30mm hex head bolts to secure the motor. Please see picture shown.

3.



4.



5.

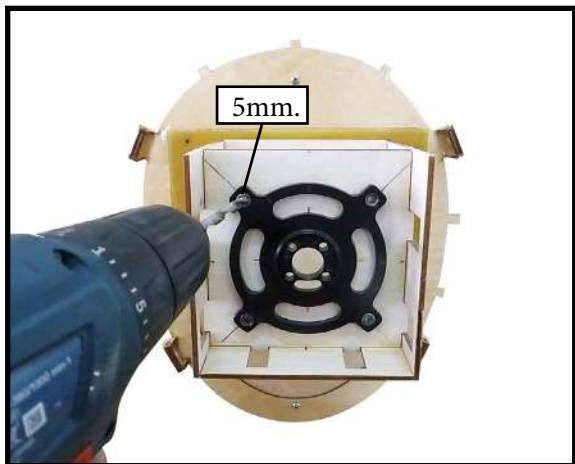

Then, use 7mm drill bit to enlarge the holes on the electric motor box.

6.

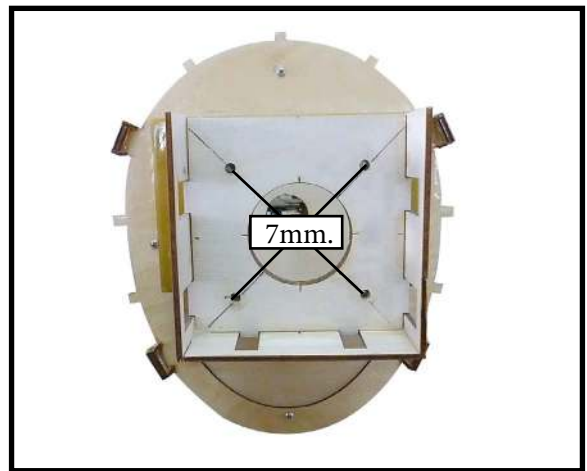

7.

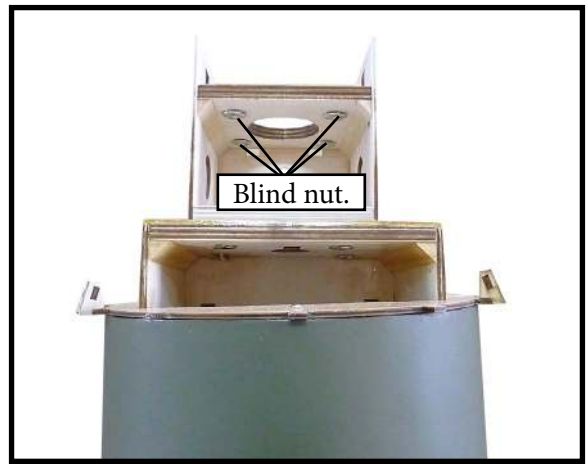

Attach the motor to the front of the electric motor box using four 5mm blind nut, four M5x20mm hex head bolts to secure the motor. Please see picture shown.

8.

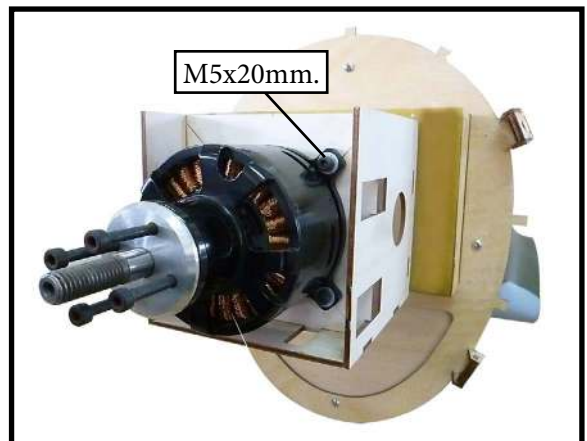

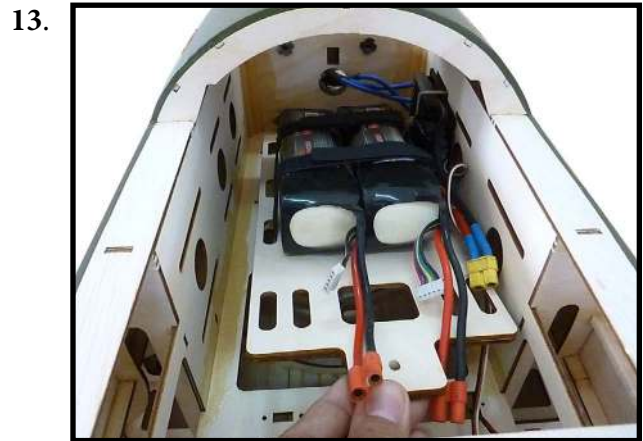
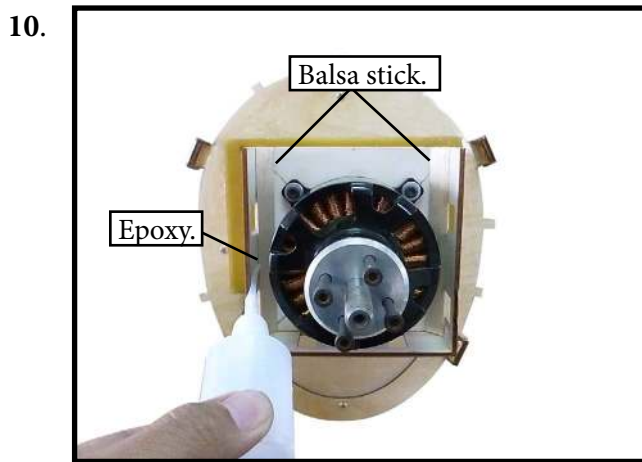
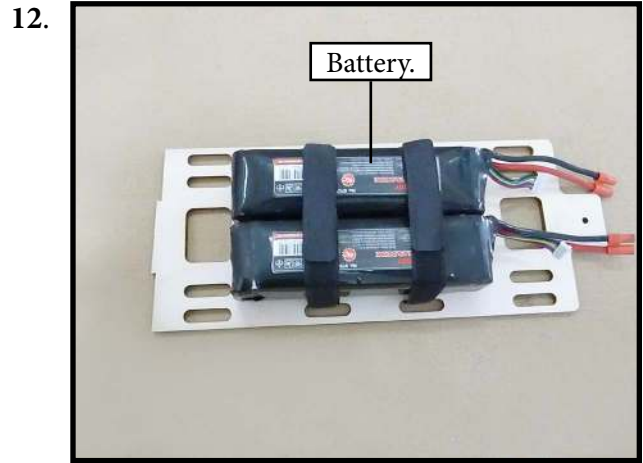
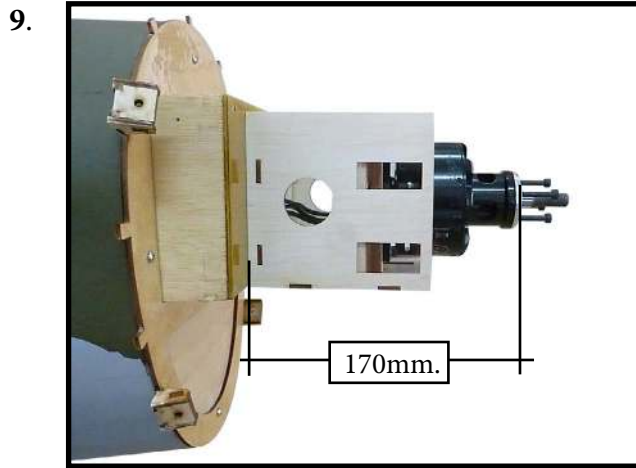

Attach the speed control to the side of the motor box using two-sided tape and tie wraps. Connect the appropriate leads from the speed control to the motor. Make sure the leads will not interfere with the operation of the motor.

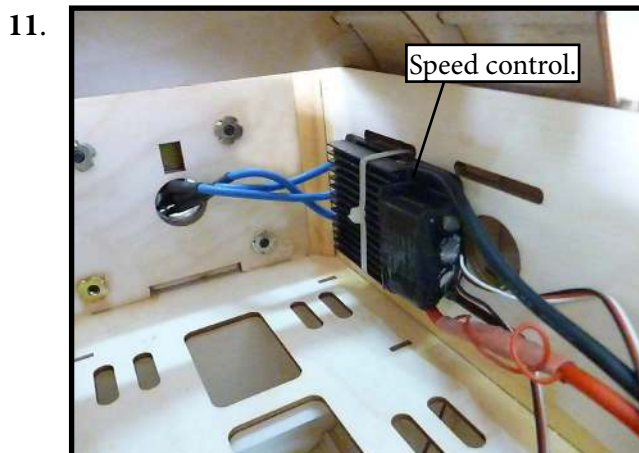

INSTALLING THE SPINNER

Install the spinner backplate, propeller and spinner cone.



 The propeller should not touch any part of the spinner cone. If it does, use a sharp modeling knife and carefully trim away the spinner cone where the propeller comes in contact with it.



INSTALL ELEVATOR CONTROL HORN

Install the elevator control horn using the same method as same as the aileron control horns.

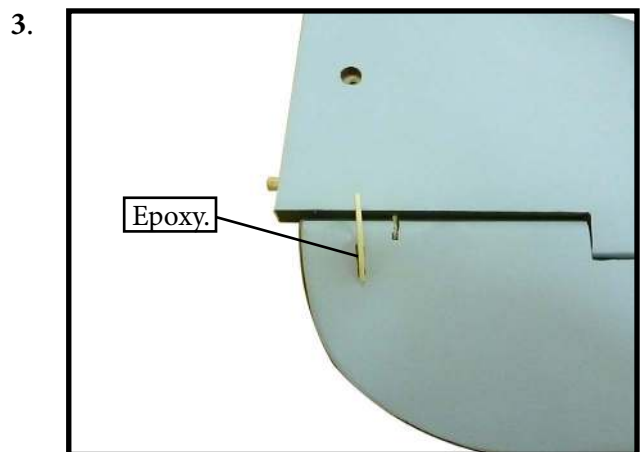
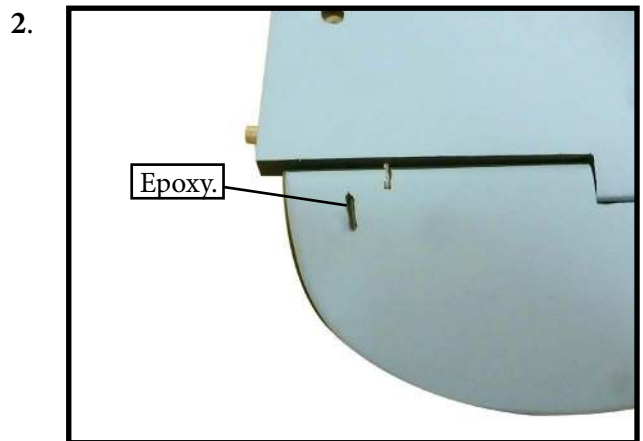
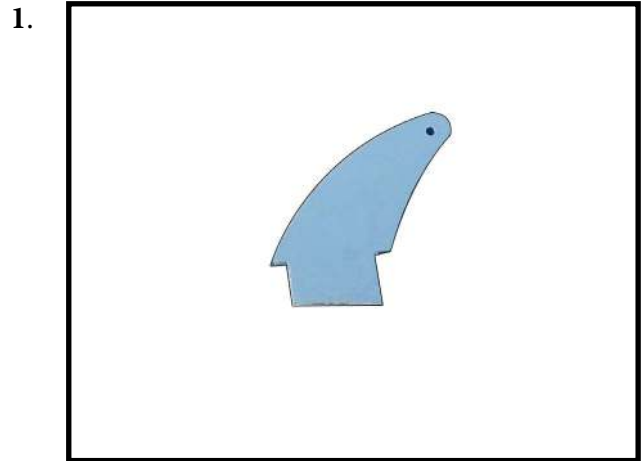

INSTALL RUDDER CONTROL HORN

Install the elevator control horn using the same method as same as the aileron control horns.

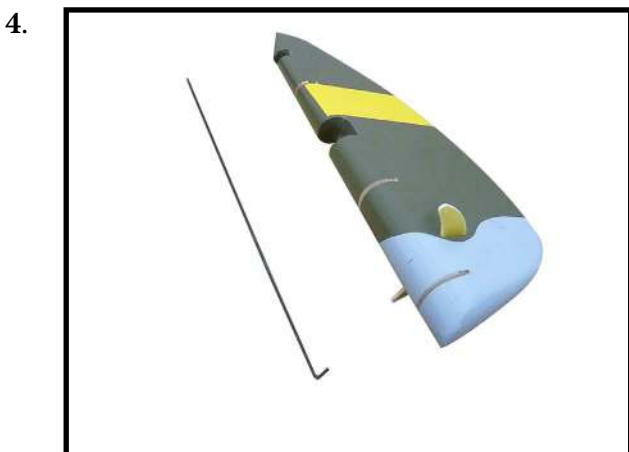
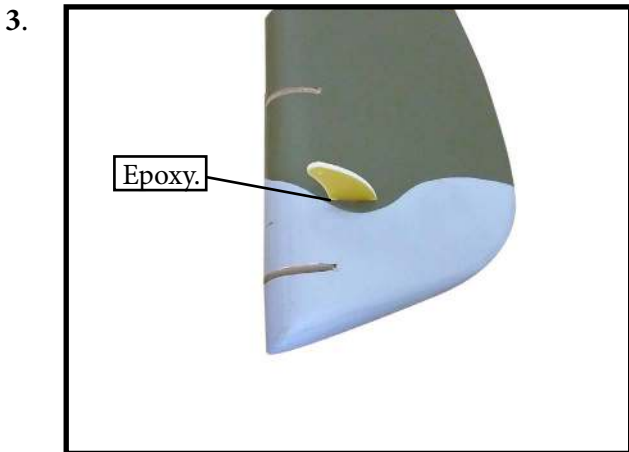
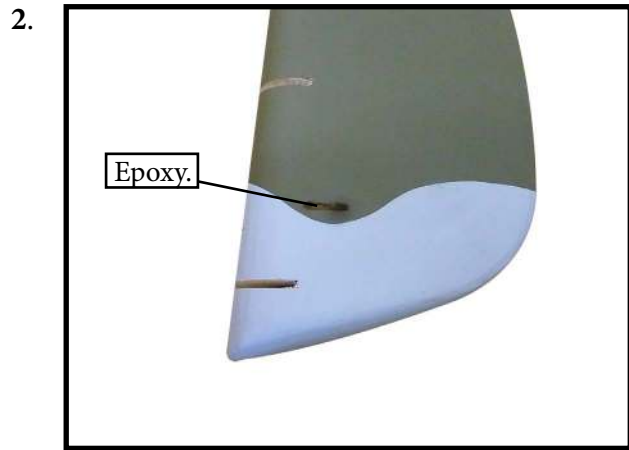
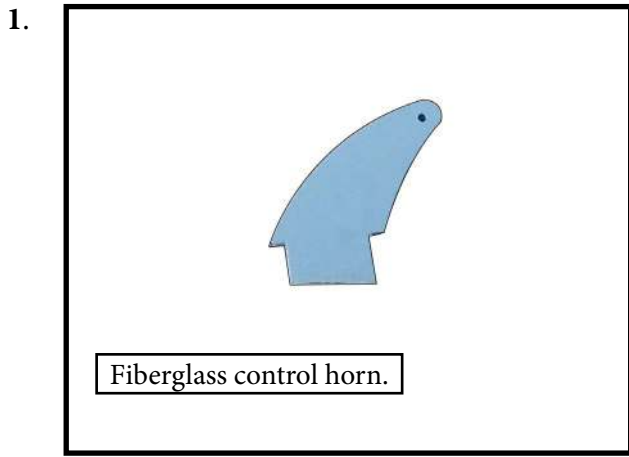

INSTALLING HORIZONTAL STABLIZER

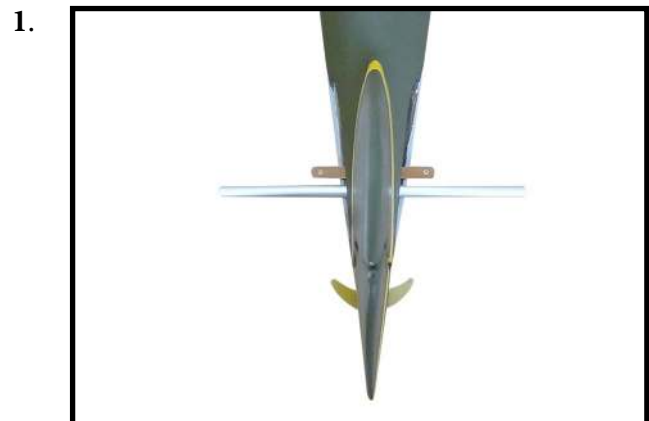

Use Epoxy Glue to glue the Horizontal Stabilizer to the fuselage.

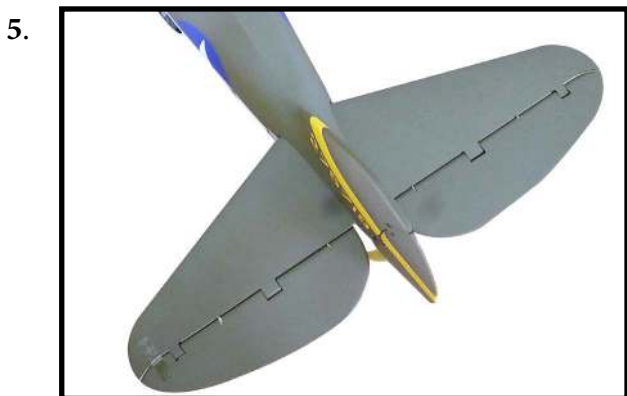
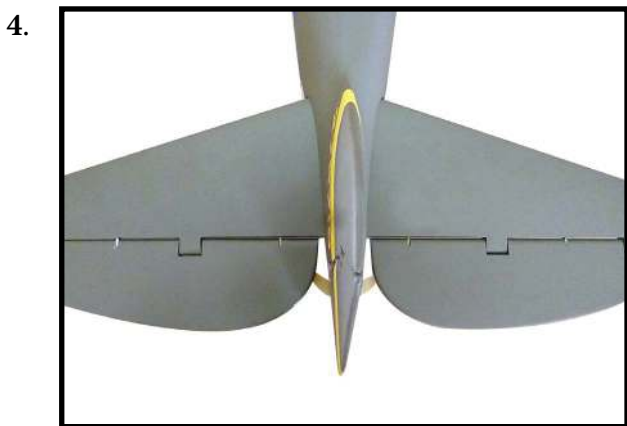
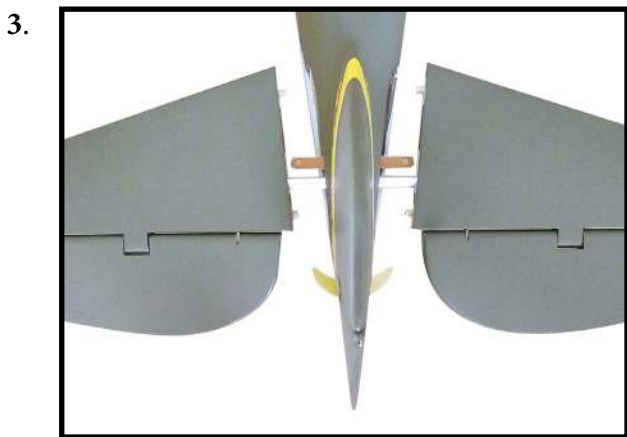

ELEVATOR PUSHROD HORN INSTALLATION

Install the elevator control horn using the same method as with the aileron control horns.

Position the elevator control horn on the both side of elevator.

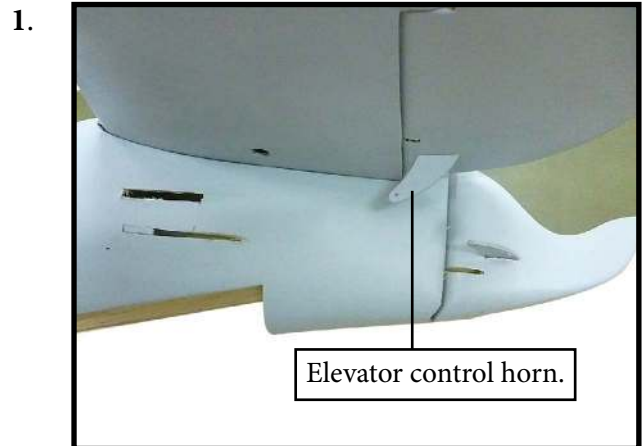

Thread one clevis and M3 lock nut on to each elevator control rod. Thread the horns on until they are flush with the ends of the control rods.

Elevator and rudder pushrods assembly as pictures below.

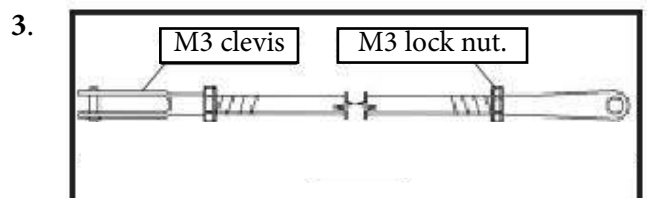
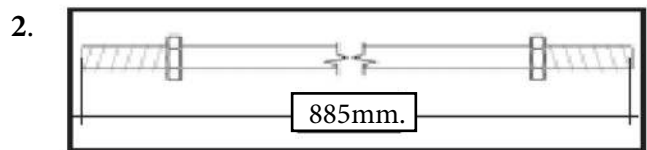

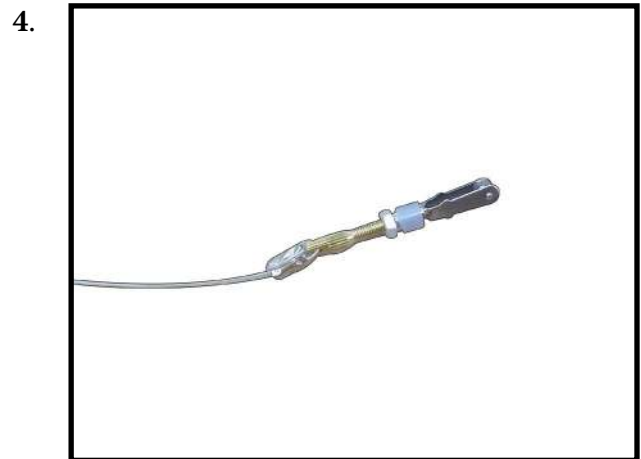
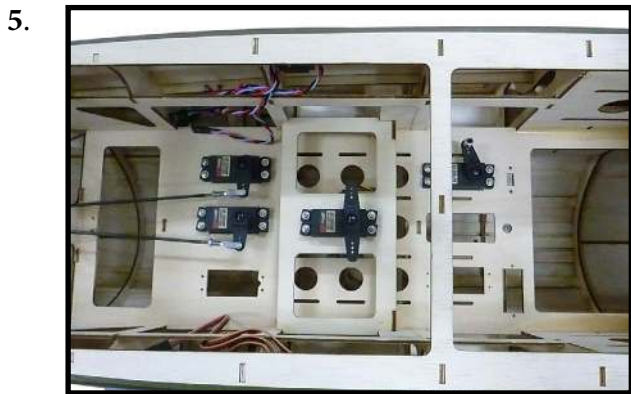
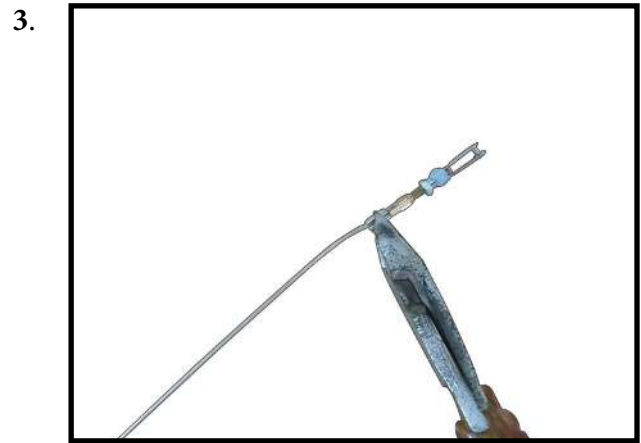
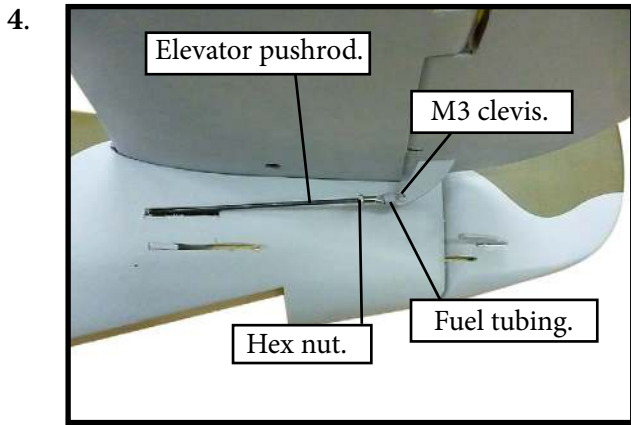

RUDDER PUSHROD INSTALLATION

Repeat steps as same as steps done for elevator.

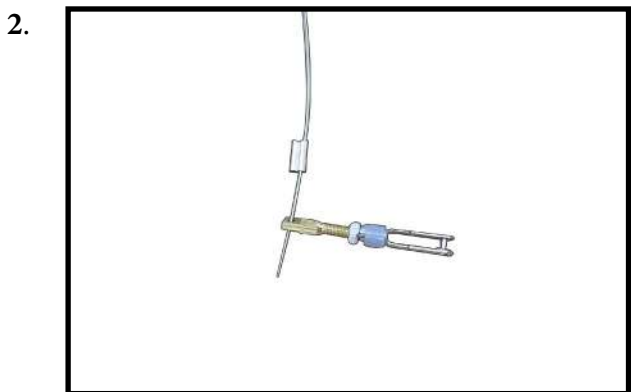
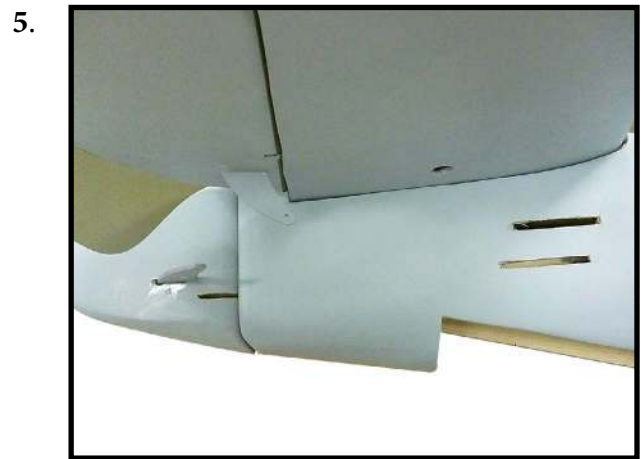
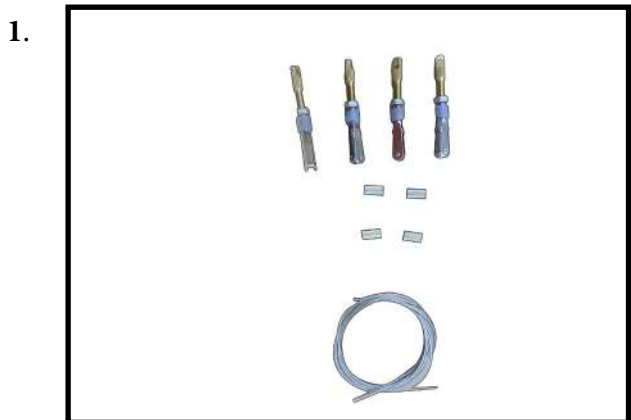

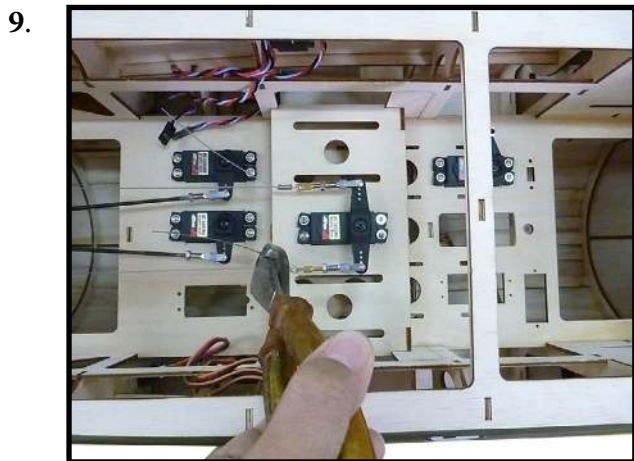
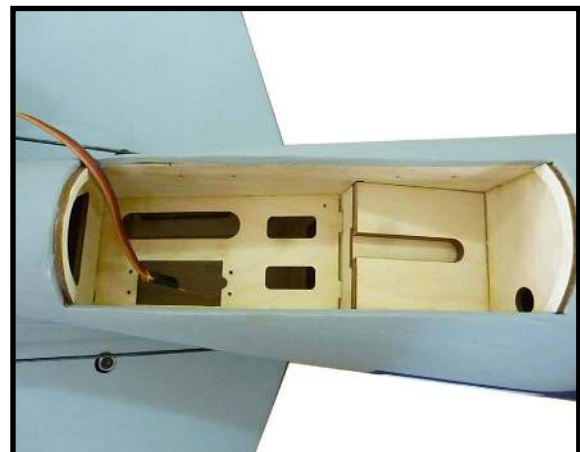
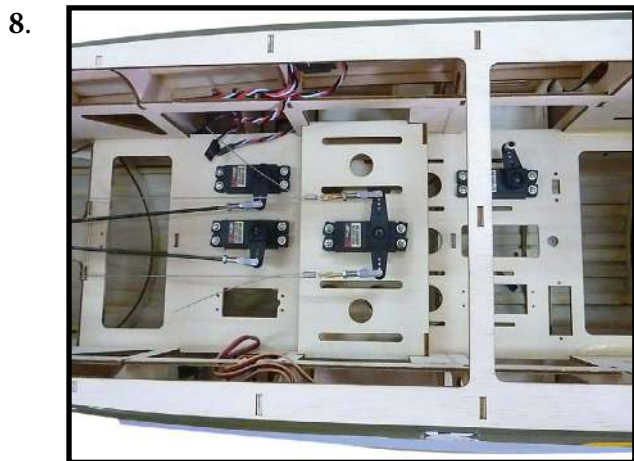
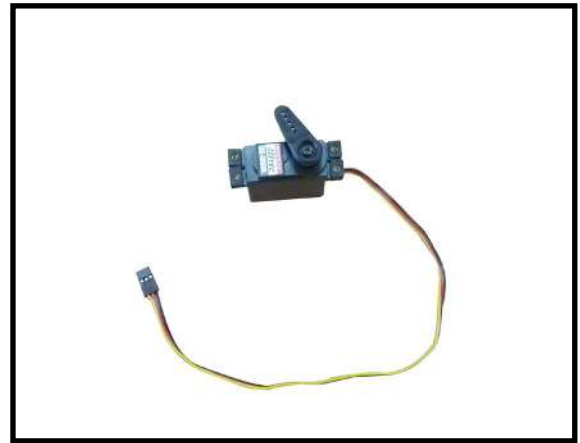
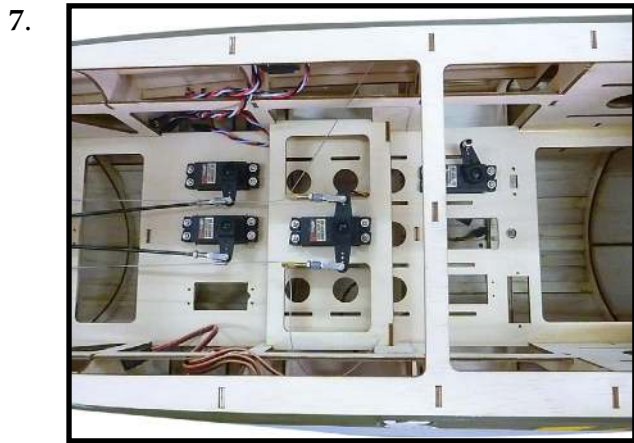

MOUNTING THE TAIL WHEEL

Locate items necessary to intall tail wheel.

Mininum servo spec.
Torque : 222 oz-in (16 kg-cm) @ 4.8V; 278 oz-in (20 kg-cm) @ 6.0V

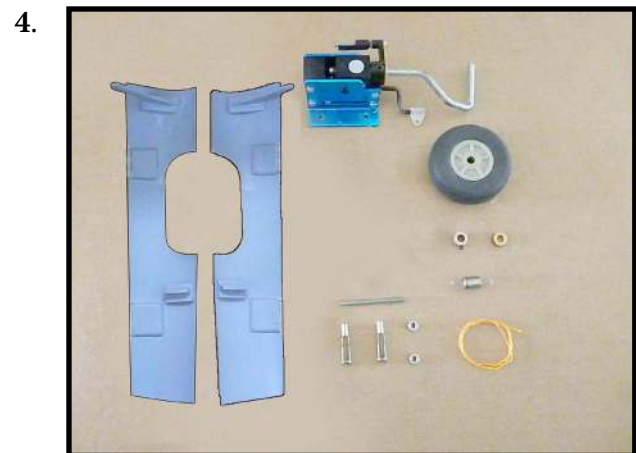

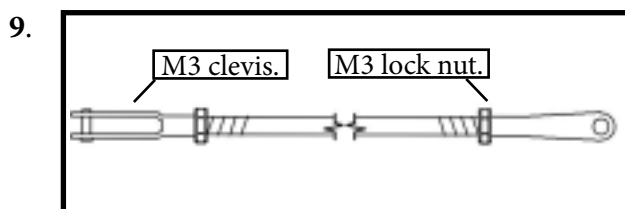
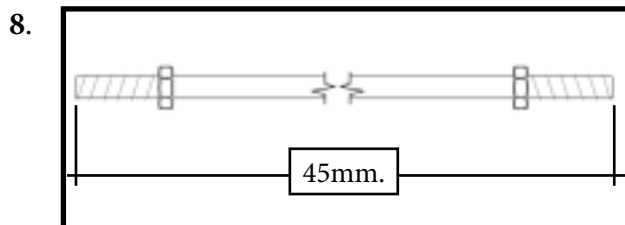
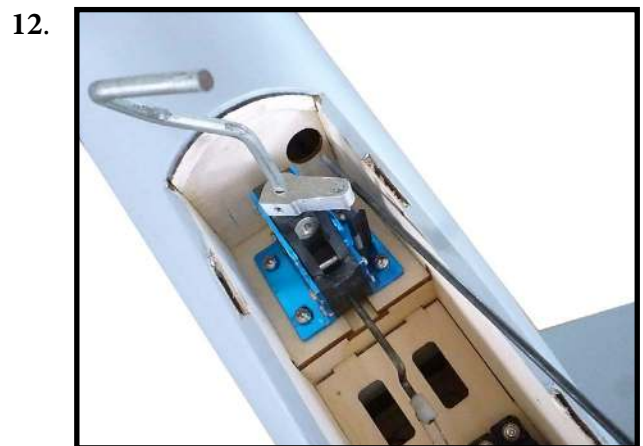
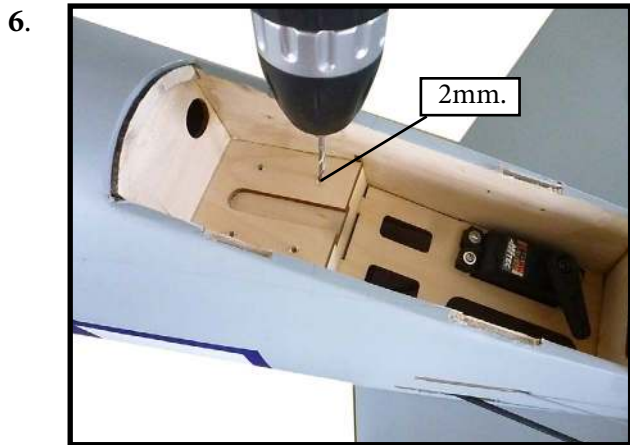
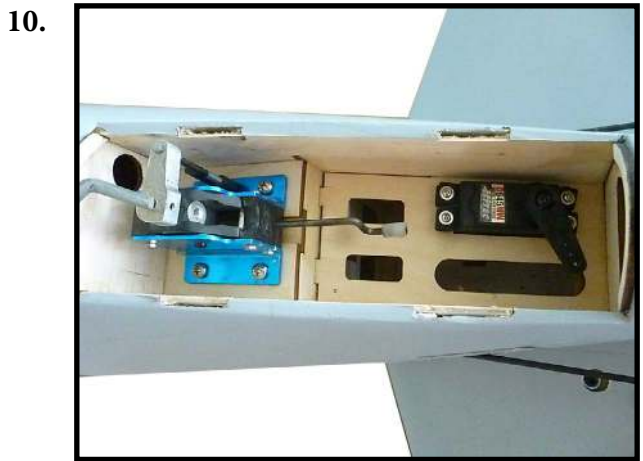
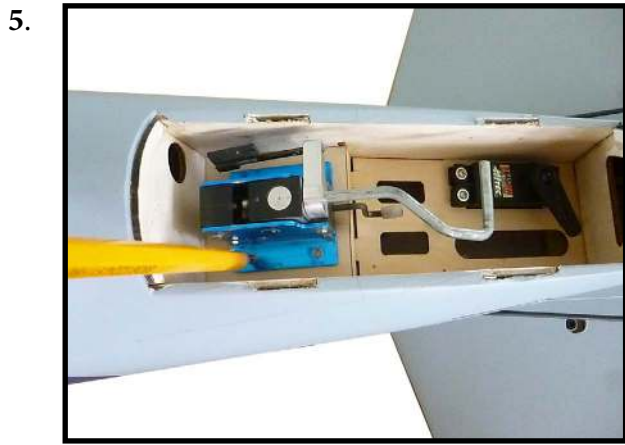

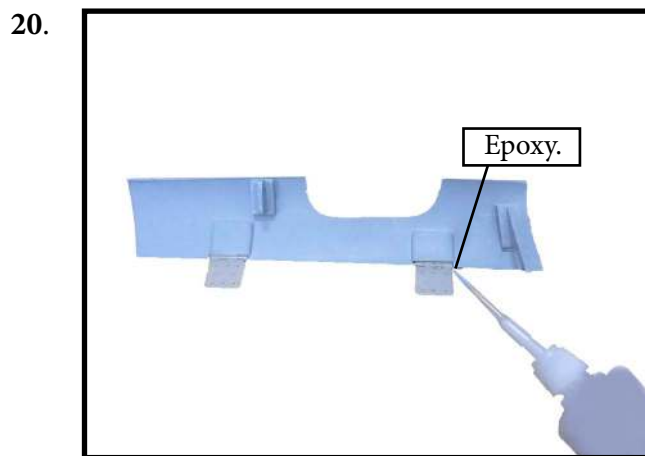
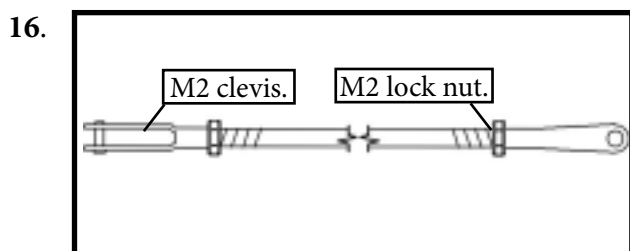
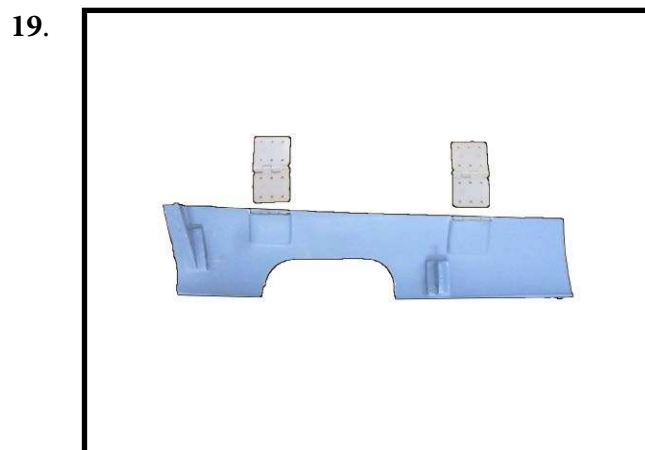
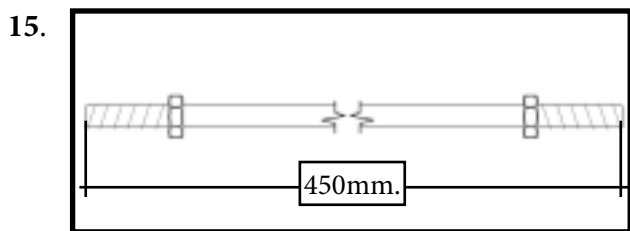
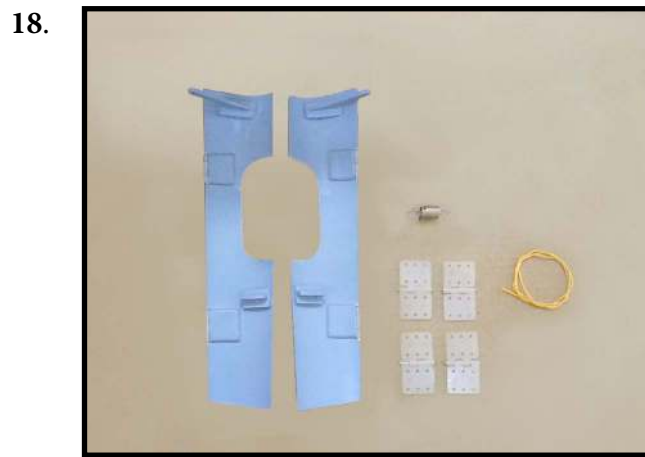
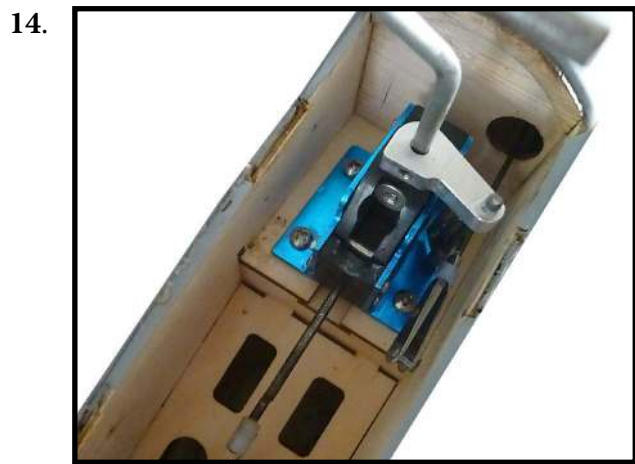

Install pushrod as shown.

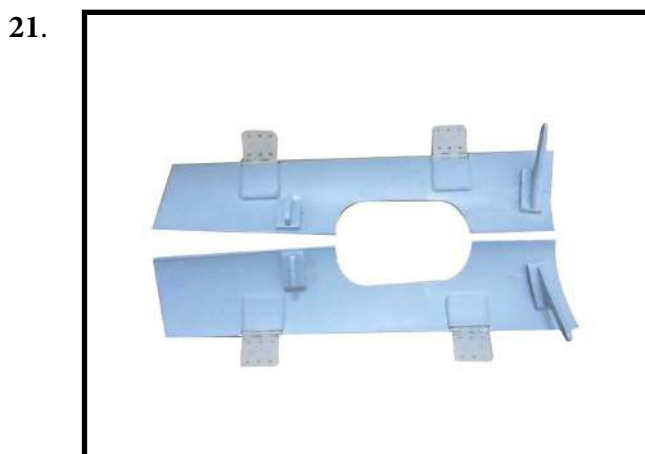
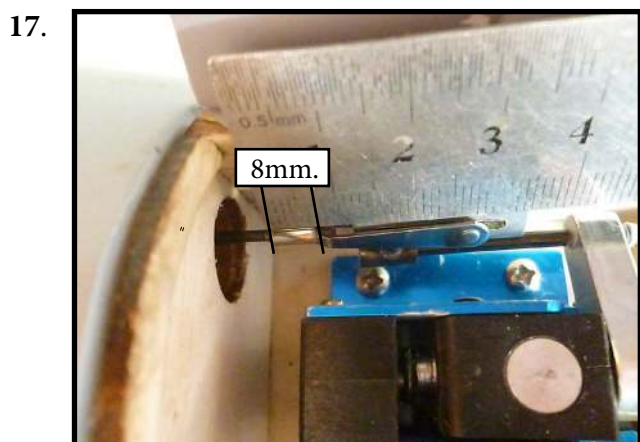

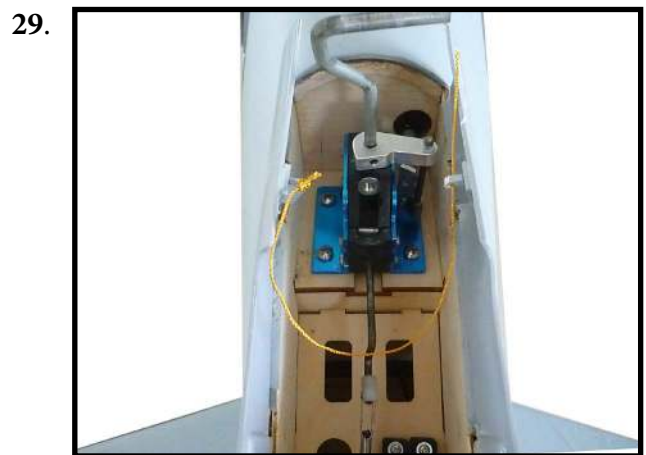
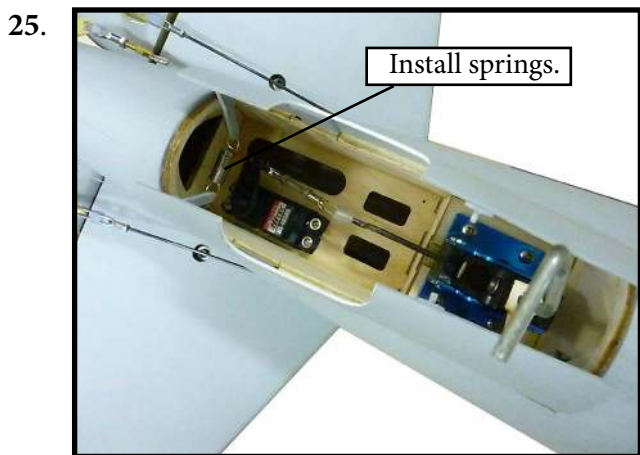
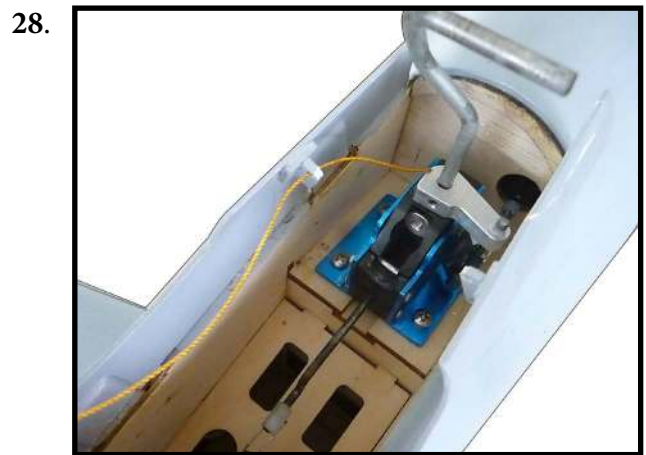
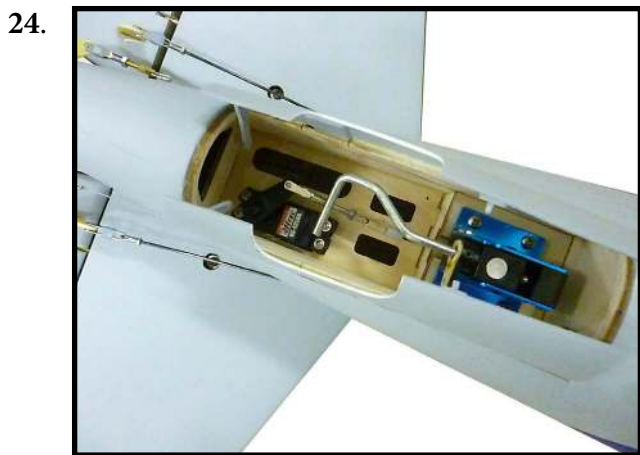
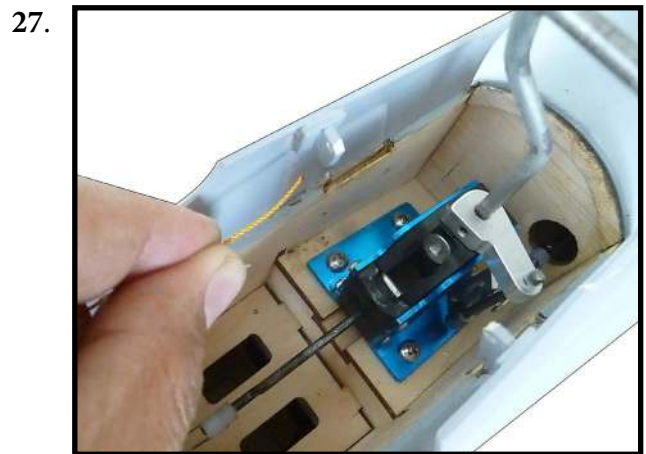
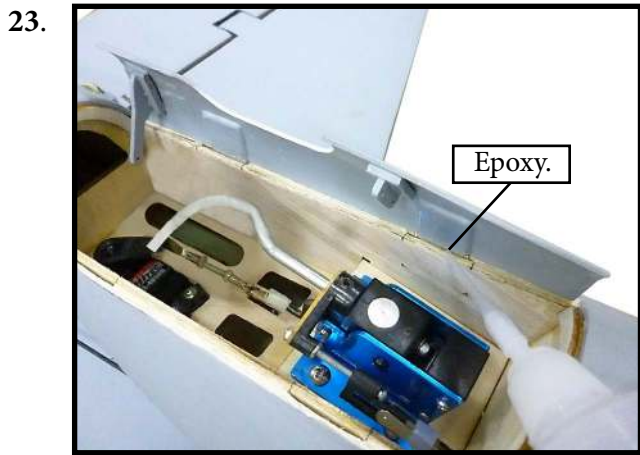
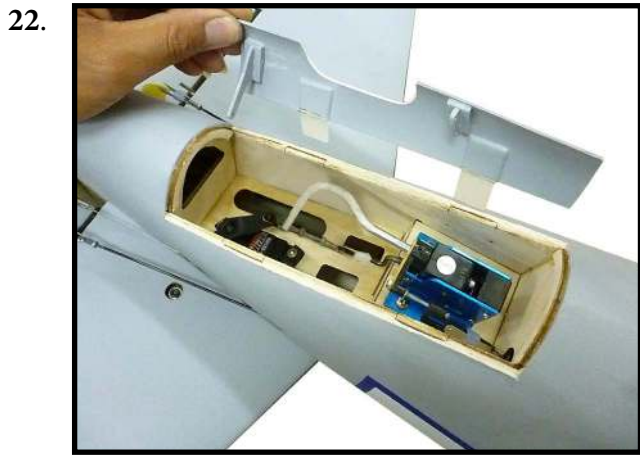

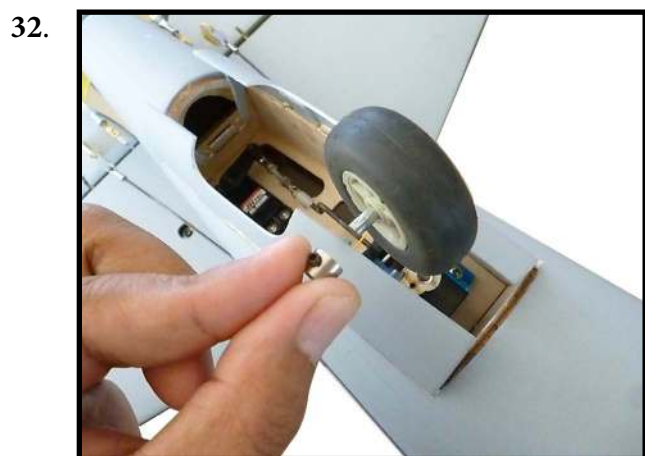
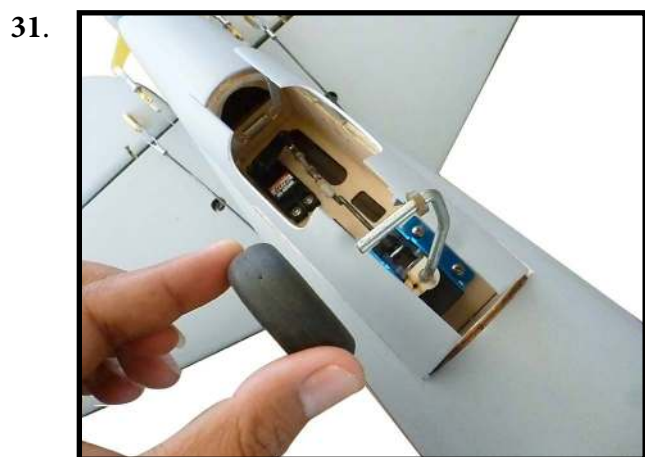
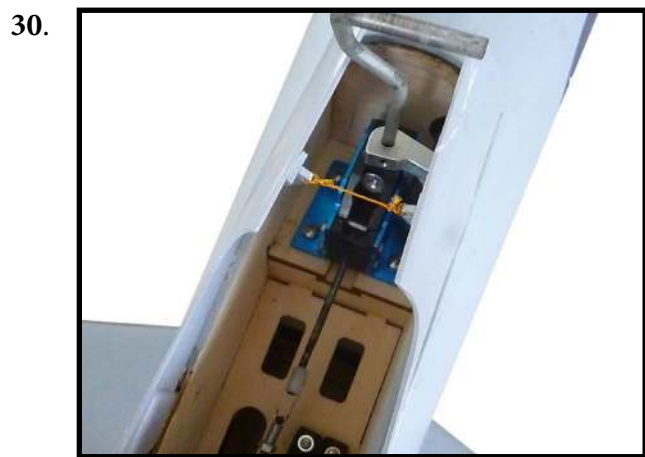

ATTCHMENT WING-FUSELAGE

Attach the aluminium tube into fuselage.

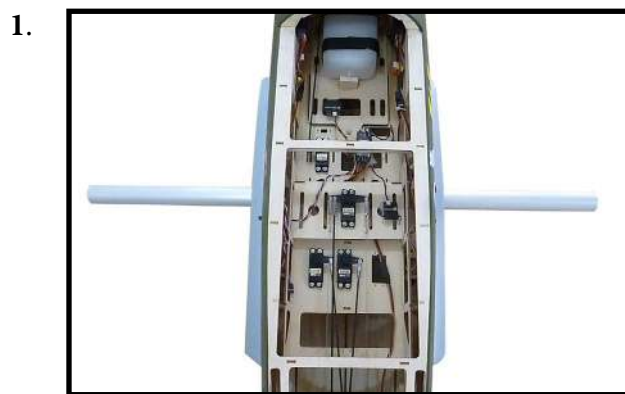

Insert two lower wing panels as pictures below..

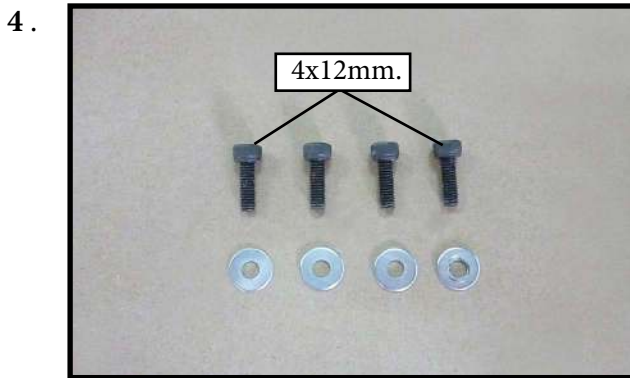
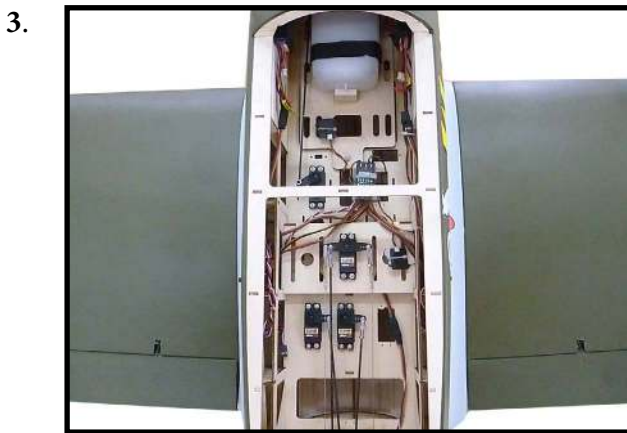
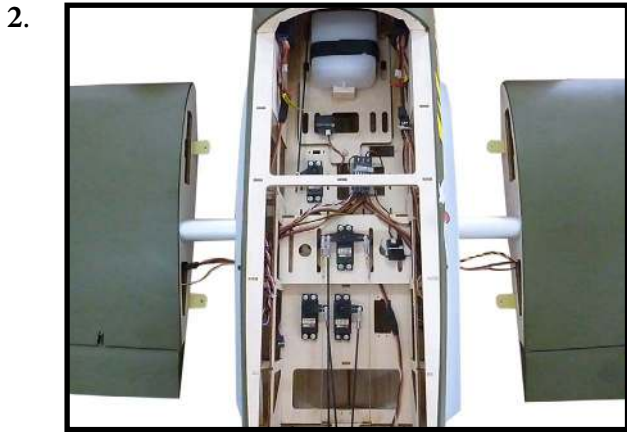

INSTALLATION COCKPIT, PILOT AND CANOPY

Locate items necessary to install.

1.



5.

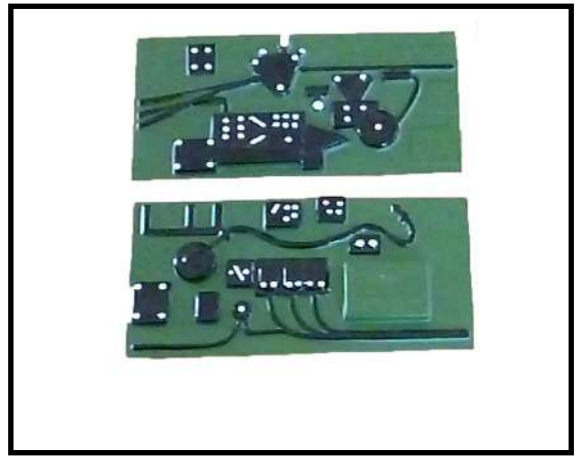

2.



6.



3.

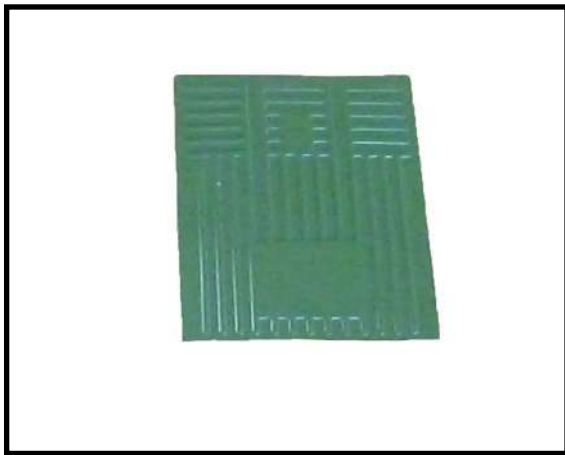

7.



4.

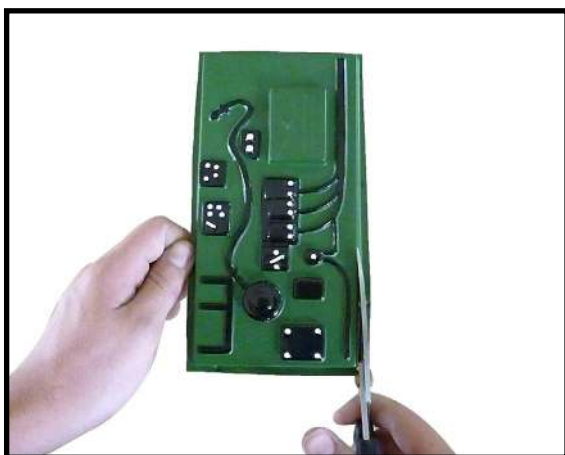

8.



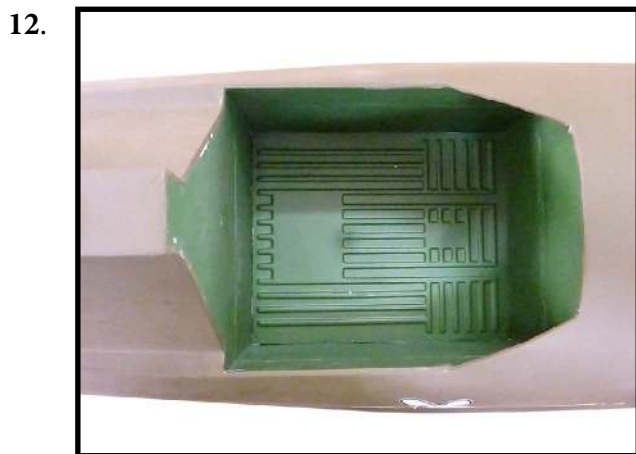
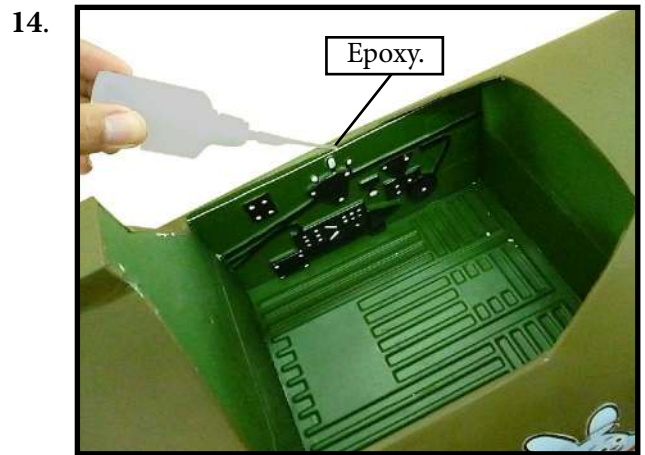
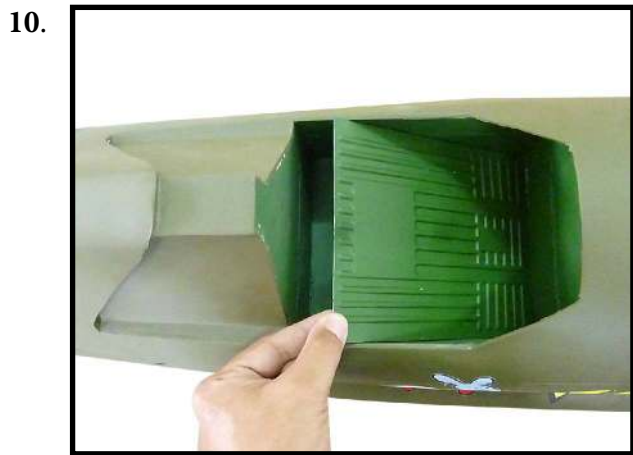

17.

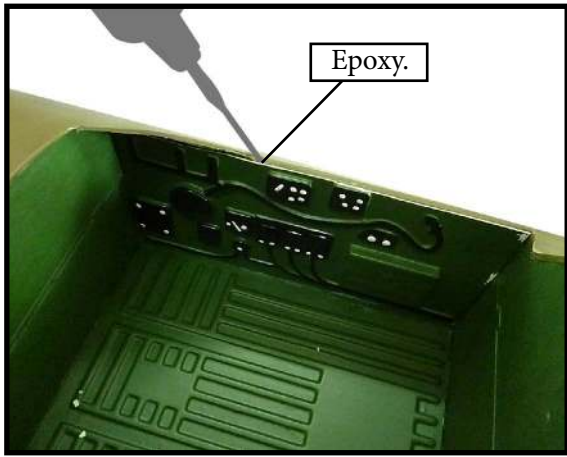

21.



18.



22.

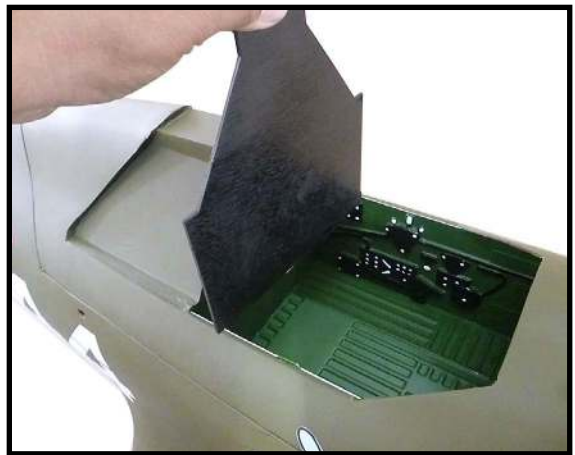

19.



23.

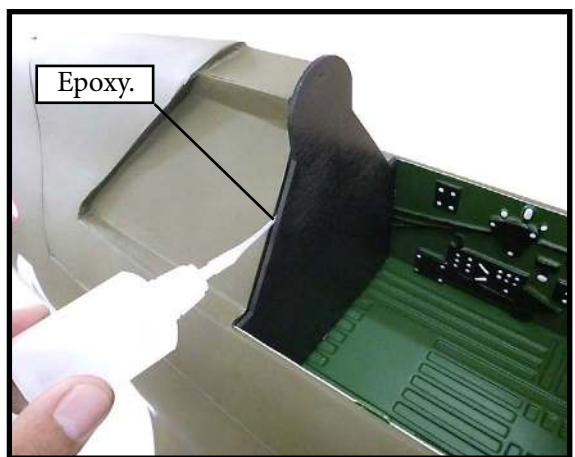

20.



24.

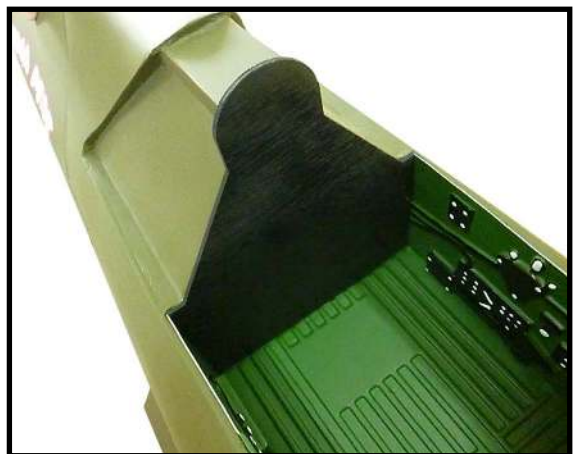

25.



29.



26.

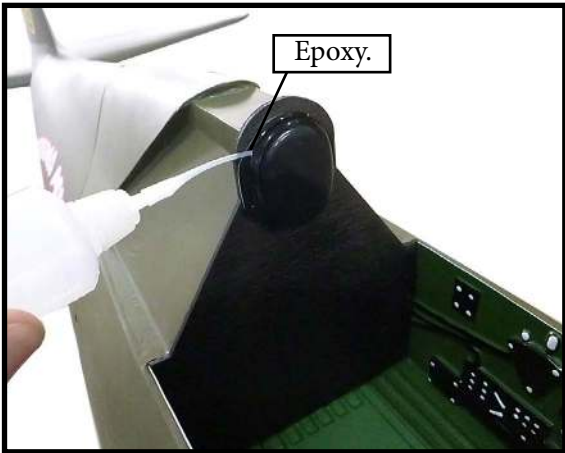

30.

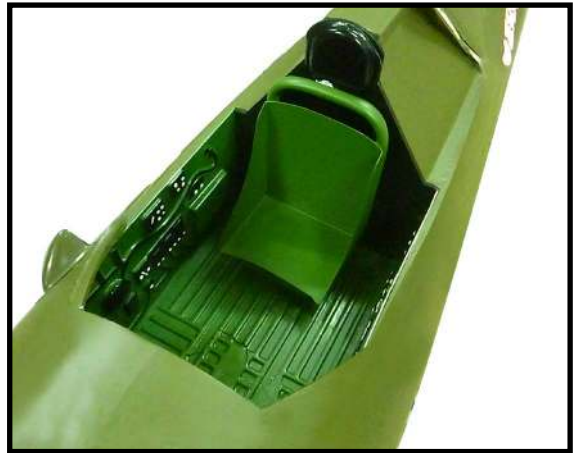

27.



31.



28.



32.



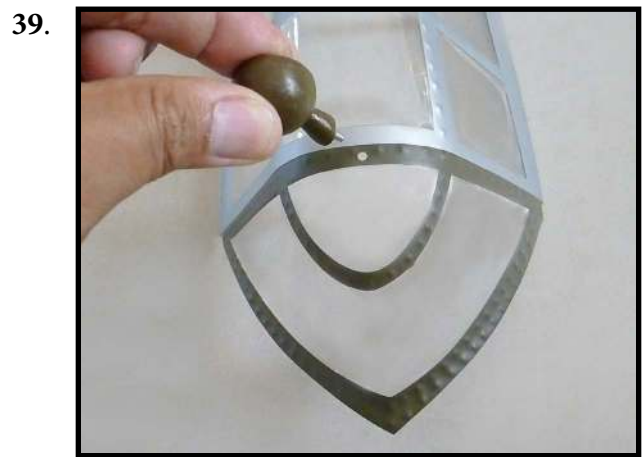
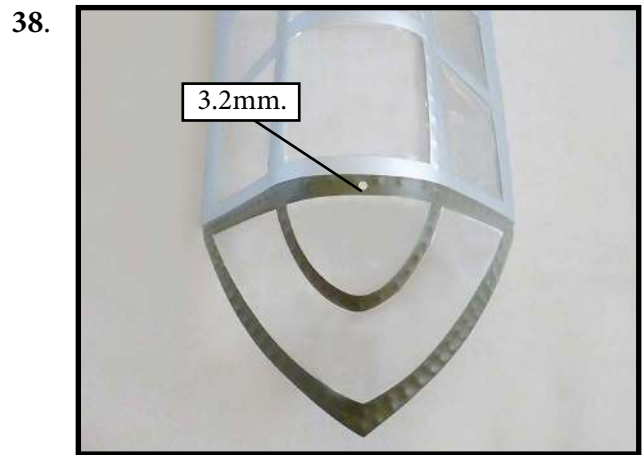
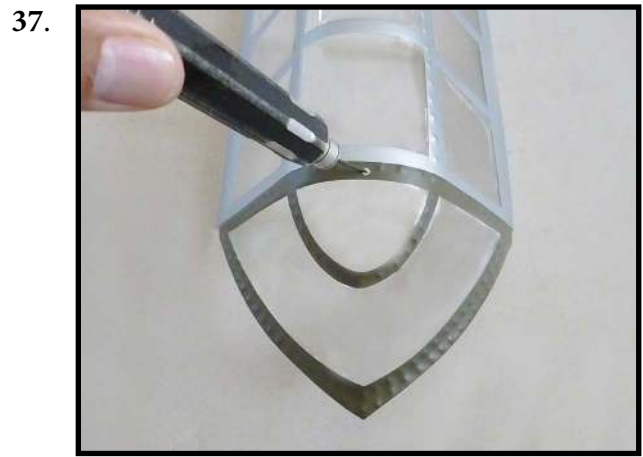

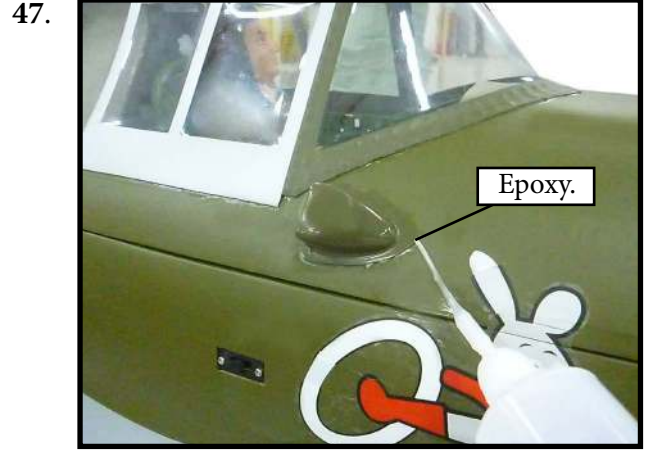

Install rearview mirror.



INSTALLING SCALE PARTS

Parts requirement. See pictures below.

1.



2.



3.



4.



5.

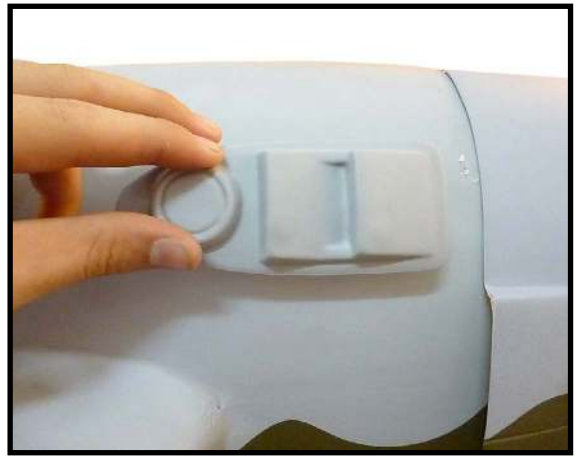

6.

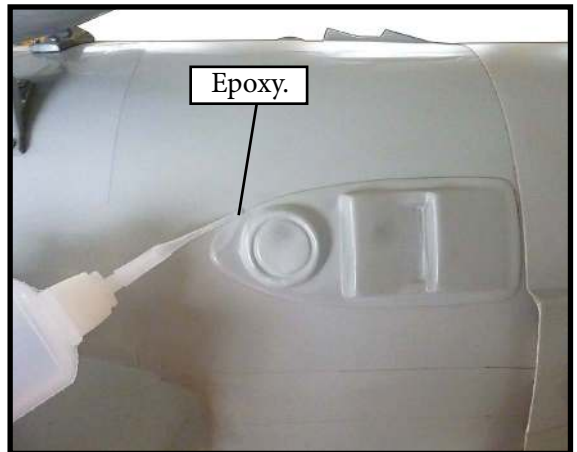

7.



8.

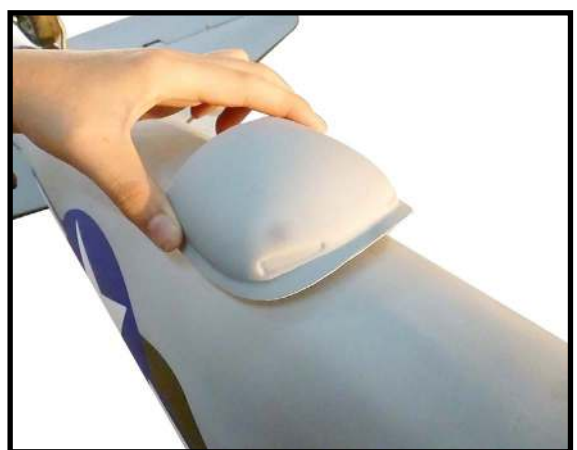

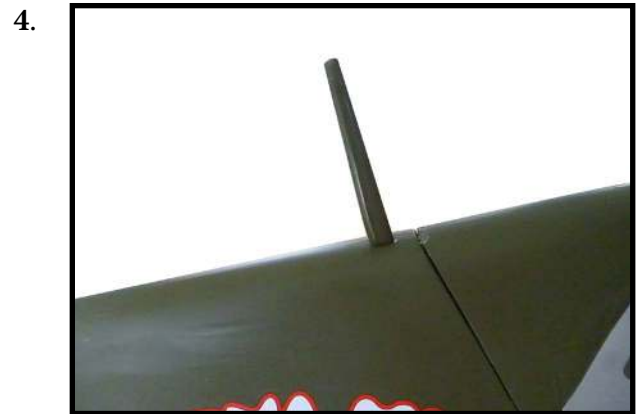
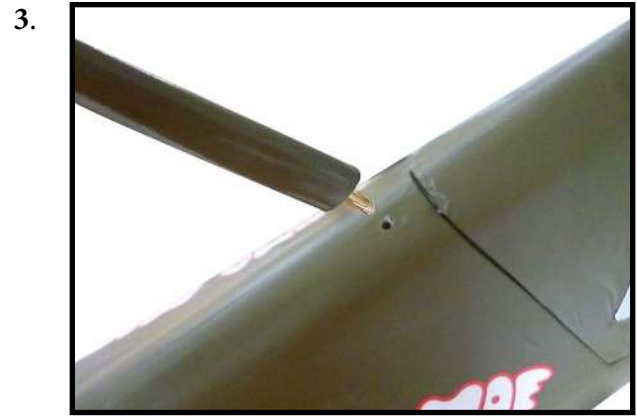
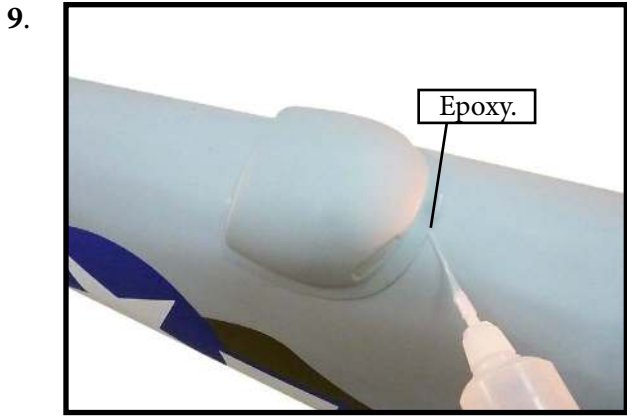

INSTALLING NEEDED ANTEN

INSTALL THE GUN ON THE WING

Parts requirement. See pictures below.

Parts requirement. See pictures below.

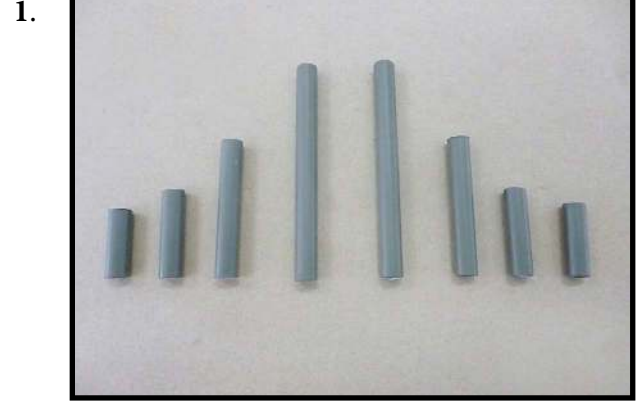

3.

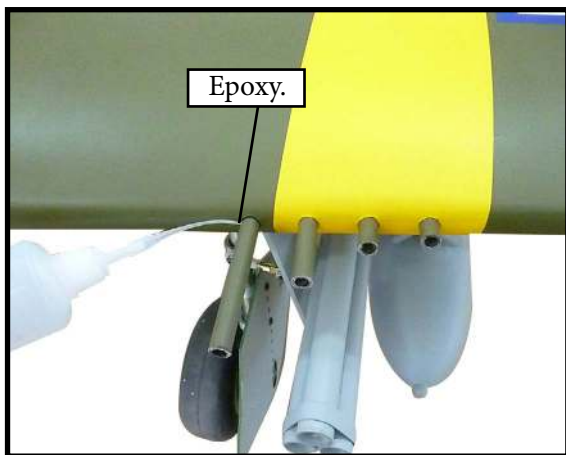

4.



APPLY THE DECALS

If all the decals are precut and ready to stick. Please be certain the model is clean and free from oily fingerprints and dust. Position decal on the model where desired, using the photos on the box and aid in their location.

If all the decals are not precut, please use scissors or a sharp hobby knife to cut the decals from the sheet. Please be certain the model is clean and free from oily fingerprints and dust. Position decal on the model where desired, using the photos on the box and aid in their location.

BALANCING

It is critical that your airplane be balanced correctly. Improper balance will cause your plane to lose control and crash. THE CENTER OF GRAVITY IS LOCATED **125-145MM** BACK FROM THE LEADING EDGE OF THE WING AT THE WING ROOT.

Mount the wing to the fuselage. Place a piece of masking tape on the top of each wing 145mm back from the leading edge at the wing root.

With the model inverted, place your fingers on the masking tape and carefully lift the plane. This is the point at which your model should balance for your first flights. Later, you may wish to experiment by shifting the balance up to 10mm forward or back to change the flying characteristics. Moving the balance forward may improve the smoothness and arrow-like tracking, but it may then require more speed for take off and make it more difficult to slow down for landing. Moving the balance aft makes the model more agile with a lighter and snappier "feel". In any case, please start at the location we recommend.

*If possible, first attempt to balance the model by changing the position of the receiver battery and receiver. If you are unable to obtain good balance by doing so, then it will be necessary to add weight to the nose or tail to achieve the proper balance point.

With the wings attached to the fuselage, all parts of the model installed (ready to fly), and empty fuel tanks, hold the model at the marked balance point with the stabilizer level.

Lift the model. If the tail drops when you lift, the model is “tail heavy” and you must add weight* to the nose. If the nose drops, it is “nose heavy” and you must add weight* to the tail to balance.

1.



CONTROL THROWS

Ailerons:	Rudder:
High Rate :	High Rate :
Up : 12 mm	Right : 15 mm
Down : 12 mm	Left : 15 mm
Low Rate :	Low Rate :
Up : 15 mm	Right : 20 mm
Down : 15 mm	Left : 20 mm
Elevator:	Flap:
High Rate :	Mid : 50mm
Up : 12 mm	Full : 60mm
Down : 12 mm	
Low Rate :	
Up : 15 mm	
Down : 15 mm	

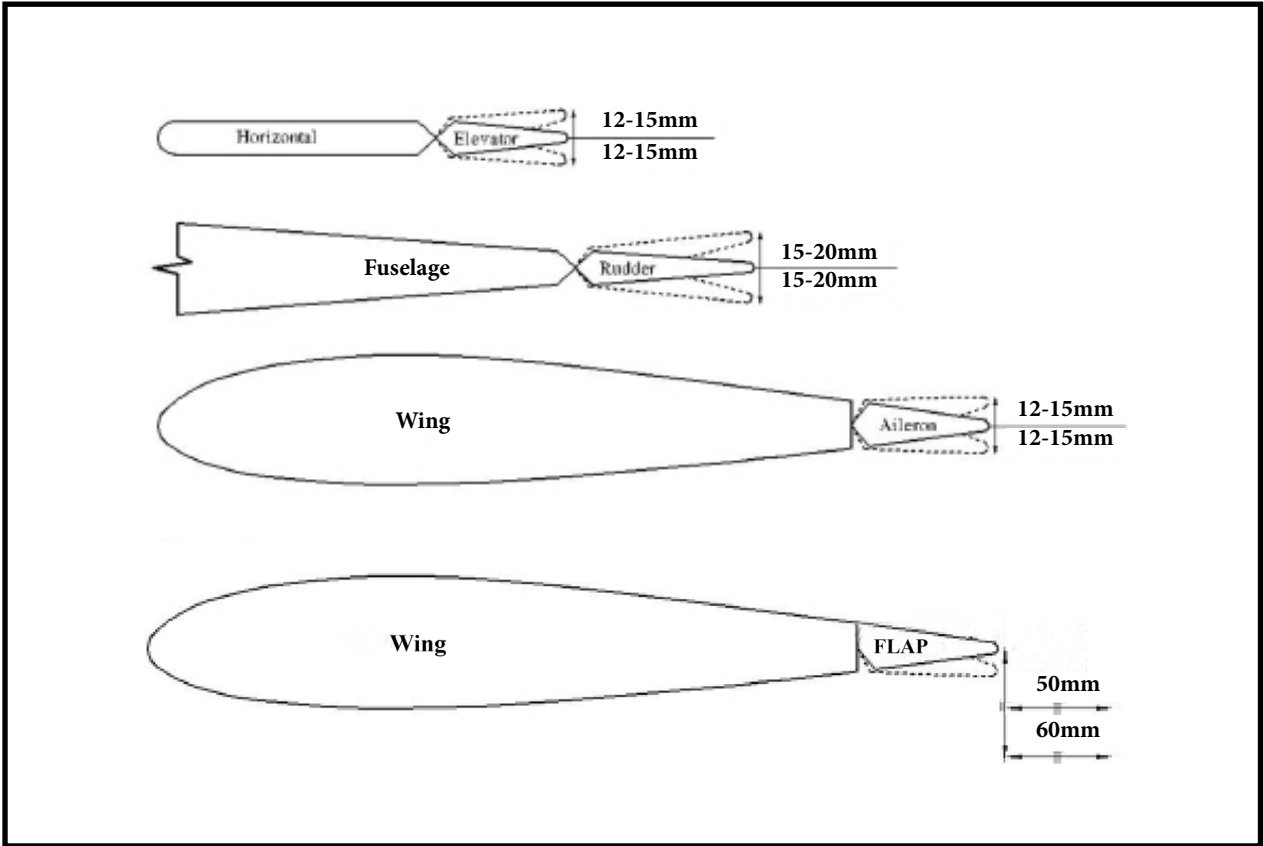

FLIGHT PREPARATION

Check the operation and direction of the elevator, rudder, ailerons and throttle.

A) Plug in your radio system per the manufacturer's instructions and turn everything on.

B) Check the elevator first. Pull back on the elevator stick. The elevator halves should move up. If they do not, flip the servo reversing switch on your transmitter to change the direction.

C) Check the rudder. Looking from behind the airplane, move the rudder stick to the right. The rudder should move to the right. If it does not, flip the servo reversing switch on your transmitter to change the direction.

D) Check the throttle. Moving the throttle stick forward should open the carburetor barrel. If it does not, flip the servo reversing switch on your transmitter to change the direction.

E) From behind the airplane, look at the aileron on the right wing half. Move the aileron stick to the right. The right aileron should move up and the other aileron should move down. If it does not, flip the servo reversing switch on your transmitter to change the direction.

PREFLIGHT CHECK

1) Completely charge your transmitter and receiver batteries before your first day of flying.

2) Check every bolt and every glue joint in the **GIANT SCALE P-47 RAZORBACK 50-61cc/EP ARF** to ensure that everything is tight and well bonded.

3) Double check the balance of the airplane. Do this with the fuel tank empty.

4) Check the control surfaces. All should move in the correct direction and not bind in any way.

5) If your radio transmitter is equipped with dual rate switches double check that they are on the low rate setting for your first few flights.

6) Check to ensure the control surfaces are moving the proper amount for both low and high rate settings.

7) Check the receiver antenna. It should be fully extended and not coiled up inside the fuselage.

8) Properly balance the propeller. An out of balance propeller will cause excessive vibration which could lead to engine and/or airframe failure.

*We wish you many safe and enjoyable flights
with your GIANT SCALE P-47 RAZORBACK 50-61cc/EP ARF .*

*If you have any queries, or are interested in our products,
please feel free to contact us*

Factory : 12/101A - Hamlet 4 - Le Van Khuong Street - Dong Thanh Ward -
Hoc Mon District - Ho Chi Minh City - Viet Nam.

Office : 62/8 Ngo Tat To Street - Ward 19 - Binh Thanh District - Ho Chi Minh
City - Viet Nam

Phone : 848 - 86622289 or 848- 36018777

Website : www.SeagullModels.com

Email : Sales@seagullmodels.com

Facebook : www.facebook.com/SeaGullModels.